

**SAMSUNG**

# SAMSUNG

## **DLP TV**

---

### Owner's Instructions

**HL-R4656W**

**HL-R5056W**

**HL-R5656W**

**HL-R6156W**

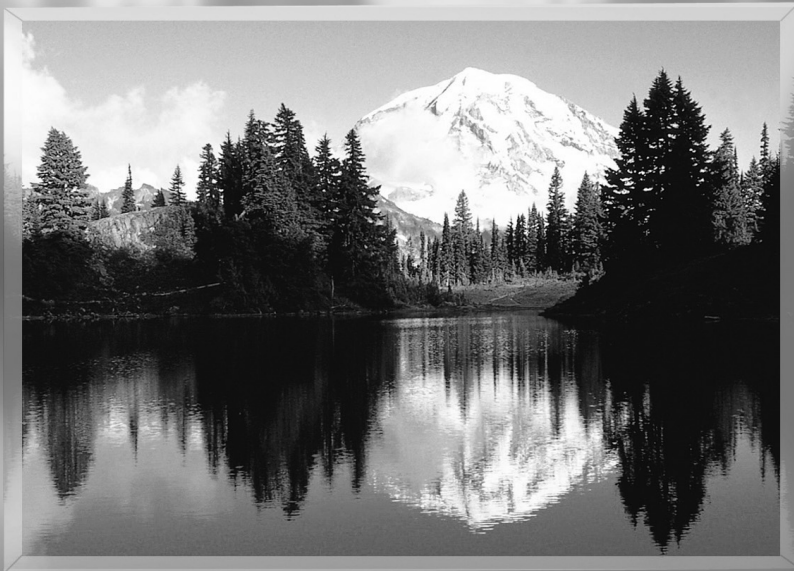

Register your product at [www.samsung.com/global/register](http://www.samsung.com/global/register)

# A Guide to Digital TV

- **What is Digital Television?**

Digital television (DTV) is a new way of transmitting high quality video and audio to your TV set. Using DTV, broadcasters can transmit high definition TV (HDTV) images, Dolby digital surround audio, and new services such as multicasting (transmitting more than one program on the same TV channel) and datacasting. Several of these services can be combined into a single digital broadcast.

## Digital Television Services

- **Digital Picture Quality**

DTV programs are transmitted in two different formats. The first is Standard Definition Television (SDTV) and the second is High Definition Television (HDTV).

- **SDTV** program formats include 480-line interlaced (480i) and 480-line progressive (480p) video. 480i programs are essentially a digital version of our current analog TV programs, while the 480p format offers improved image detail over 480i. Some 480p programs are broadcast in widescreen and are comparable to progressive-scan DVD movies in image quality.

- **HDTV** program formats include 1080-line interlaced (1080i) and 720-line progressive (720p). Both HDTV formats are always broadcast in widescreen, and offer much higher picture quality than SDTV.

- **Dolby Surround Sound**

With DTV, you can listen to a variety of Dolby digital audio formats from Dolby Surround 2.0 to Dolby Digital 5.1 surround, using your home audio system. Many HDTV programs are now broadcast with DD 5.1 soundtracks.

### U.S.A Only

The product unit accompanying this user manual is licensed under certain intellectual property rights of certain third parties. In particular, this product is licensed under the following US patents: 5,991,715, 5,740,317, 4,972,484, 5,214,678, 5,323,396, 5,539,829, 5,606,618, 5,530,655, 5,777,992, 6,289,308, 5,610,985, 5,481,643, 5,544,247, 5,960,037, 6,023,490, 5,878,080, and under US Published Patent Application No. 2001-44713-A1.

This license is limited to private non-commercial use by end-user consumers for licensed contents. No rights are granted for commercial use. The license does not cover any product unit other than this product unit and the license does not extend to any unlicensed product unit or process conforming to ISO/IEC 11172-3 or ISO/IEC 13818-3 used or sold in combination with this product unit. The license only covers the use of this product unit to encode and/or decode audio files conforming to the ISO/IEC 11172-3 or ISO/IEC 13818-3. No rights are granted under this license for product features or functions that do not conform to the ISO/IEC 11172-3 or ISO/IEC 13818-3.

### Other countries

The product unit accompanying this user manual is licensed under certain intellectual property rights of certain third parties. This license is limited to private non-commercial use by end-user consumers for licensed contents. No rights are granted for commercial use. The license does not cover any product unit other than this product unit and the license does not extend to any unlicensed product unit or process conforming to ISO/IEC 11172-3 or ISO/IEC 13818-3 used or sold in combination with this product unit. The license only covers the use of this product unit to encode and/or decode audio files conforming to the ISO/IEC 11172-3 or ISO/IEC 13818-3. No rights are granted under this license for product features or functions that do not conform to the ISO/IEC 11172-3 or ISO/IEC 13818-3.

## Q&A

### **1. Is the antenna I use for existing TV reception good enough for DTV?**

Over-the-air (OTA) digital TV broadcasting uses the same channels as analog TV and works well with many existing TV antennas. However, DTV broadcast channel assignments are different than analog channels. You should find out whether your local DTV broadcasts are on VHF (channels 2-13) or UHF (channels 14-69) to see if you need a different antenna.

If your DTV channels are on UHF and you already get good UHF reception, your present antenna may work fine. The same holds true for VHF DTV reception. Note that in some markets, both VHF and UHF channels are used for DTV broadcasts.

You can find out the latest DTV channel assignments for your area by browsing selected Internet web sites such as [www.titanTV.com](http://www.titanTV.com), [www.10000watts.com](http://www.10000watts.com), and [www.fcc.gov](http://www.fcc.gov).

### **2. How difficult is it to receive DTV signals indoors?**

This depends on whether your local DTV stations are running full power or not and how close your location is to the transmission tower. DTV receivers do not require as much signal as analog TV receivers to produce high-quality images and sound.

Once the DTV signal level exceeds a certain threshold at the receiver, the digital video and audio data is decoded at the same quality it was originally encoded for broadcast.

This is a big advantage for DTV over analog TV - there is no noise, ghosting, static, or scratchy audio.

### **3. How can I connect an antenna in my townhouse, co-operative apartment, condominium, or apartment?**

The Federal Communications Commission's OTARD Rule (part of the Telecommunications Act of 1996) allows residents of condominiums, townhouse, or members of neighborhood associations to put up outside antennas for reception of broadcast TV signals as long as those antennas are not located in common areas and are no more than 12' in height.

Residents of rental units (apartments, etc.) are not covered by the OTARD rules and will have to use indoor antennas to receive DTV broadcasts. It is possible that the landlord of an apartment complex can provide broadcast DTV signals via a master TV antenna system to each apartment.

### **4. Can I connect my DTV set-top receiver to my cable TV service?**

Cable TV systems use a different method for transmitting digital TV programs that is currently incompatible with broadcast DTV set-top receivers. So you will still need to use an outdoor or indoor antenna to receive OTA broadcast DTV programs.

The good news is that you won't have to pay a monthly or per-program charge to watch OTA DTV and HDTV programs. They're free, unlike subscription satellite TV or premium cable TV. All you need is an antenna and a DTV set-top receiver to enjoy clear, sharp widescreen images and high-quality audio.

# Table of Contents

Your New Wide TV .....	8
Viewing Position .....	8
List of Features.....	9
Checking Accessories.....	9
Right side buttons.....	10
Side Panel Jacks .....	10
Front Panel LED Indicators.....	11
Rear Panel Jacks.....	12
Remote Control.....	13
Connections .....	16
Connecting VHF and UHF Antennas .....	16
Antennas with 75-ohm Round Leads .....	16
Connecting Cable TV .....	17
Cable without a Cable Box.....	17
Cable with a Cable Box that Descrambles All Channels.....	17
Cable with a Cable Box that Descrambles Some (But Not All) Channels .....	18
Connecting a VCR .....	19
Connecting a VCR to the Video or S-Video/Audio jack.....	19
Connecting a Camcorder .....	20
Connecting a DVD Player .....	21
Connecting to Y, PB, PR.....	21
Connecting to Audio and Video Jacks.....	21
Connecting a DTV Set-Top Box .....	22
Connecting to Y, PB, PR.....	22
Connecting to DVI (Digital Visual Interface) .....	22
Connecting to HDMI (High Definition Multimedia Interface).....	23
Connecting a Digital Audio System.....	24
Connecting to an Analog Amplifier.....	24
Operation .....	26
Turning the TV On and Off .....	26
Viewing the Menus and On-Screen Displays .....	26
Selecting a Menu Language.....	27
Memorizing the Channels .....	28
Adding and Erasing Channels.....	30
Changing Channels .....	31
Customizing Your Remote Control .....	32
Remote Control Codes.....	33
Setting the Clock.....	34
Setting the On/Off Timer.....	36
Setting the Sleep Timer .....	37
Viewing an External Signal Source .....	38
Assigning Names to External Input Mode .....	39

Channel Control .....	42
Selecting Your Favorite Channels .....	42
Labeling the Channels .....	43
Fine Tuning Analog Channels <b>Analog</b> .....	44
Checking the Digital-Signal Strength <b>Digital</b> .....	45
LNA (Low Noise Amplifier) .....	46
Picture Control .....	48
Picture Control .....	48
Changing the Picture Size .....	51
Digital Noise Reduction .....	52
Viewing the DNle Demonstration .....	53
Setting the My Color Control Mode .....	54
Using the Color Weakness Enhancement Feature .....	56
Setting the Film Mode .....	57
Freezing the Picture .....	58
Setting the Blue Screen Mode .....	59
Sound Control .....	62
Sound Control .....	62
Auto Volume .....	64
Choosing a Multi-Channel Sound (MTS) track <b>Digital</b> .....	65
Choosing a Multi-Channel Sound (MTS) track <b>Analog</b> .....	66
Choosing a Digital Sound Format <b>Digital</b> .....	67
Selecting the Internal Mute .....	68
Setting the On/Off Melody .....	69
Setting up DNSe (Digital Natural Sound engine) .....	70
Special Features .....	72
Setting the Function Help .....	72
Menu Transparency Level .....	73
Using the V-Chip .....	74
Viewing Closed Captions (On-Screen Text Messages) <b>Analog</b> .....	84
Viewing Closed Captions (On-Screen Text Messages) <b>Digital</b> .....	86
Using the Guide .....	88
Using Game Mode .....	90
Appendix .....	92
Replacing the Lamp .....	92
Troubleshooting .....	94
Cleaning and Maintaining Your TV .....	95
Using Your TV in Another Country .....	95
Specifications .....	95

---

SAMSUNG



# **Your New Wide TV**



# Your New Wide TV

## Viewing Position

To optimize your viewing comfort, please follow the guidelines below for viewing distance. If viewing for an extended period of time, sit as far back from the screen as possible.

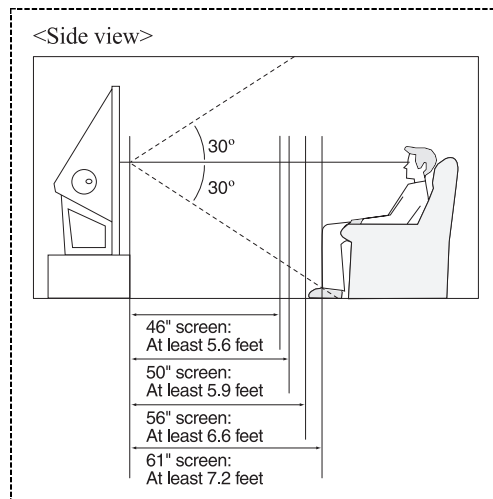
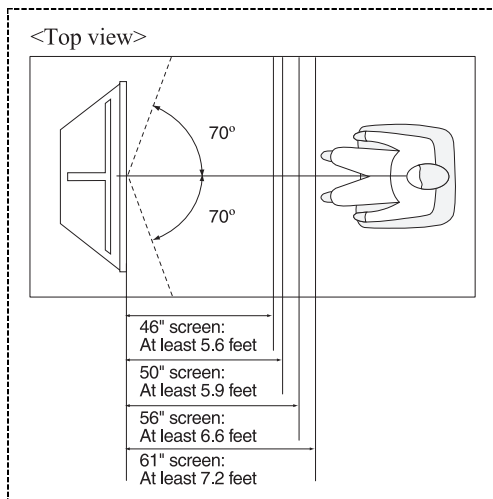

When installing the product, make sure to keep it away from the wall (more than 10 cm/4 inches) for ventilation purposes.

- Poor ventilation may cause an increase in the internal temperature of the product, resulting in a shortened component life and degraded performance.

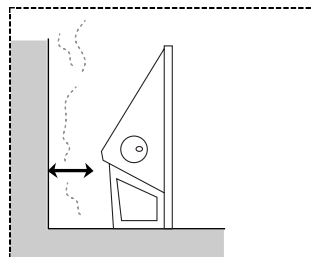



## List of Features

Your TV was designed and engineered using the latest technology. It is a full-featured, high-performance unit that exceeds industry standards. In addition, it has these special features:

- Easy-to-operate remote control
- Easy-to-use on-screen menu system you can access from right side buttons or remote control
- Automatic timer to turn the TV on and off at any time you choose
- Adjustable picture and sound settings and the ability to memorize your favorite settings
- Automatic channel tuning for up to 181 channels
- A special filter to reduce or eliminate reception problems
- Fine tuning control for the sharpest picture possible
- A built-in multi-channel sound decoder for stereo and bilingual listening
- Built-in, dual channel speakers
- A special sleep timer
- Widescreen TV with adjustable image size
- Life-like clear images provided by DNle technology
- My Color Control Mode for corresponding with your color style
- Color weakness Mode
- Digital Input (HDMI/DVI IN) jack
- Digital Audio Output (OPTICAL) jack
- AV network system (Anynet) that enables you to easily control Samsung audio-video(AV) devices from this TV.

## Checking Accessories

Once you have unpacked your TV, check to make sure that you have all the parts shown here. If any piece is missing or broken, call your dealer.



Owner's Instructions



Remote Control (BP59-00084B)/  
AAA Batteries



Anynet Cable  
(BN39-00518B)

The following parts are sold separately and are available at most electronics stores.



S-VIDEO Cable



HDMI Cable



HDMI/DVI cable



Component Cables (RCA)



Optical Cable



Antenna Cable

# Your New Wide TV

## Right side buttons

The buttons on the right side panel control your TV's basic features, including the on-screen menu system. To use the more advanced features, you must use the remote control.

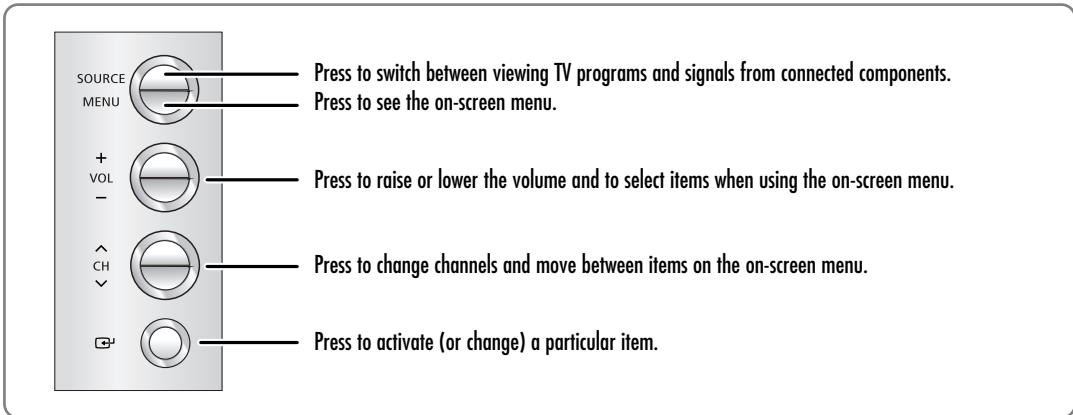

## Side Panel Jacks

Use the right side panel jacks to connect a component that is used only occasionally (a camcorder or video game, for example).

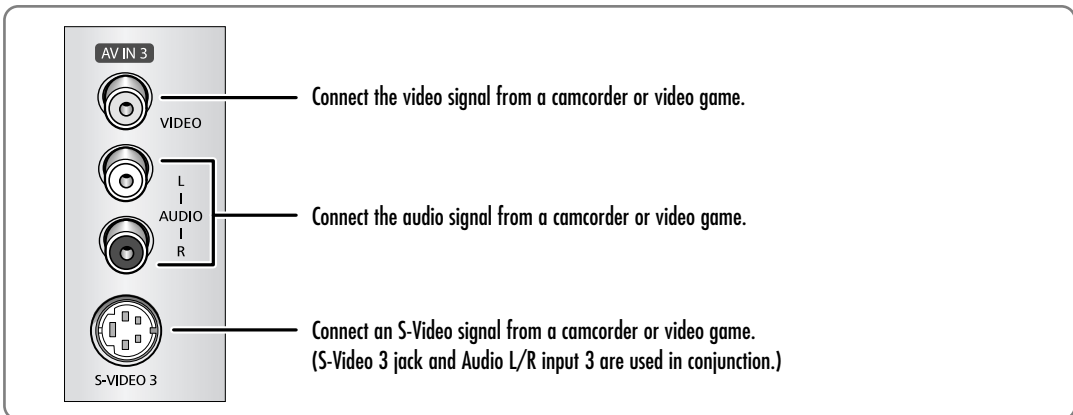

## Front Panel LED Indicators

The three lights on the front panel indicate the status of your TV.

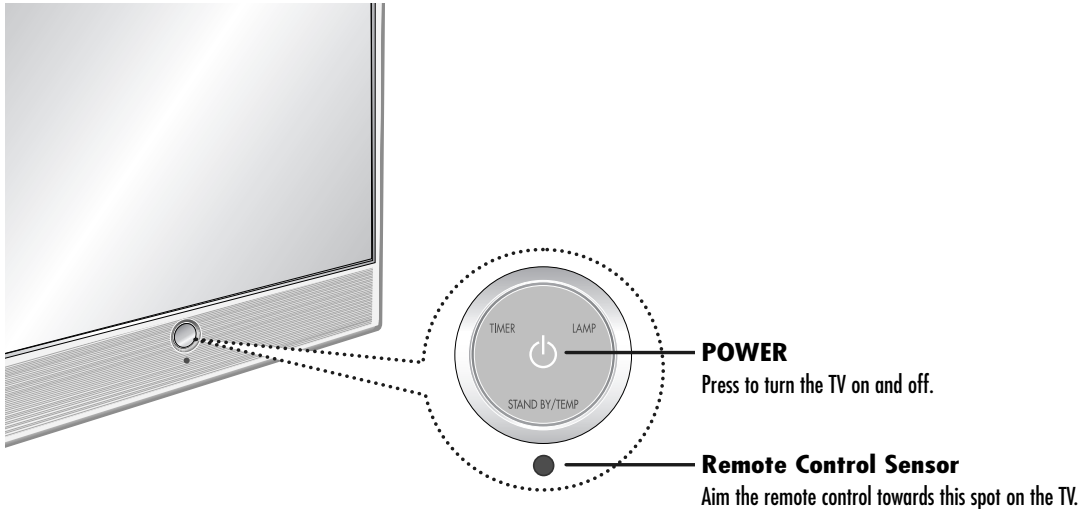

### Indicator Light Key

- : Light is On
- ◐ : Light is Blinking
- : Light is Off

TIMER	LAMP	STAND BY/TEMP	Indication
○	○	●	Standby state.
○	◐	○	The picture will automatically appear in about 15 seconds.
●	◐	○	Auto Timer ON/OFF has been set and the set will automatically be turned on in about 25 seconds.
◐	○	◐	A cooling fan inside the set is not operating normally.
○	◐	◐	Lamp cover on the rear of the set is not properly shut.
○	○	◐	Check if the ventilation hole on the rear of the set is blocked, because if the inner temperature is too high, the power will shut off.
◐	◐	◐	Lamp may be defective. Please contact a certified technician.

- It takes about 30 seconds for the TV to warm up, so normal brightness may not appear immediately.
- The TV has a fan to keep the inside lamp from overheating. You'll occasionally hear it working.

# Your New Wide TV

## Rear Panel Jacks

Use the rear panel jacks to connect components such as a VCR. You can connect different components such as VCRs, Set-Top Box and a DVD player etc., because there are two sets of video input jacks and two sets of component video input jacks on the rear panel of your TV. For more information, see "Connections".

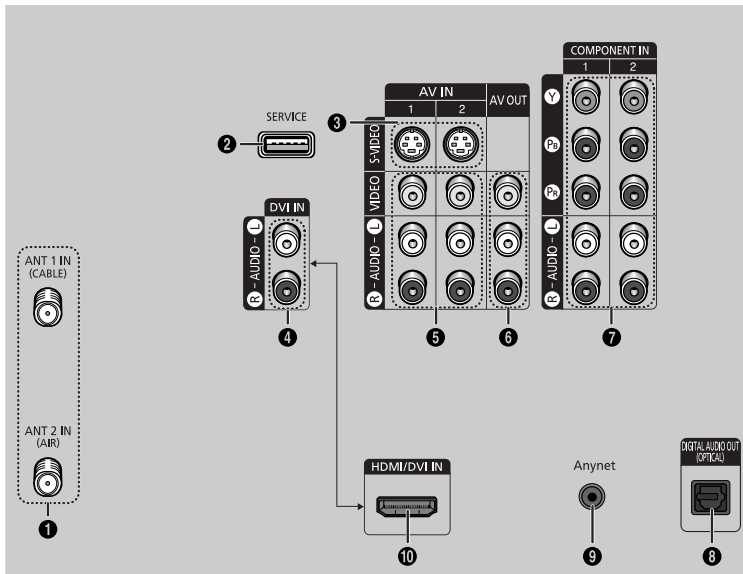

### 1 ANTENNA terminals

Two independent cables or antennas can be connected to these terminals. Use "ANT 1 IN (CABLE)" and "ANT 2 IN (AIR)" terminals to receive a signal from VHF/UHF antennas or your cable system. (Refer to pages 16~18)

### 2 SERVICE

This jack is for software upgrades.

### 3 S-VIDEO INPUT jacks

Connects an S-Video signal from an S-VHS VCR or DVD player. (Refer to page 20)

### 4 DVI (Digital Video Interface) AUDIO INPUT jacks

Connect to the digital audio output jacks of a device with DVI output. (Refer to page 22)

### 5 VIDEO/AUDIO INPUT jacks

Connect video/audio signals from external sources, such as VCR or DVD players. (Refer to page 21)

### 6 VIDEO/AUDIO OUTPUT jacks

Sends video/audio signals from the TV to an external source, such as a VCR. These jacks are available only in RF, Video and S-Video modes.

### 7 COMPONENT 1, 2 jacks (Y, PB, PR, AUDIO L/R)

Use these jacks to connect the component video/audio signals from a DVD player or a Set-Top Box. (Refer to pages 21~22)

### 8 DIGITAL AUDIO OUT (OPTICAL) jack

Connect to a Digital Audio Component. (Refer to page 24)

### 9 Anynet

Please refer to the Anynet Owner's Instruction. This jack is for connecting to other Samsung Anynet-enabled devices.

### 10 HDMI (High Definition Multimedia Interface)/DVI INPUT jack

Connect to the HDMI jack of a device with HDMI output. These inputs can also be used as a DVI connection with separate analog audio inputs. An optional HDMI/DVI cable will be necessary to make this connection. When using the optional HDMI/DVI adapter, the DVI analog audio inputs on your TV allow you to receive left and right audio from your DVI device. (Refer to pages 22~23)

# Remote Control

You can use your remote control within a distance of 23 feet and an angle of 30 degrees from the left and right sides of the TV's remote control receiver. You can also use your remote control to operate your VCR, Cable box, DVD player or some Samsung Set-top boxes. See pages 32~33 for details.

- 1. POWER**  
Turns the TV on and off.
- 2. P.MODE**  
Adjust the TV picture by selecting one of the preset factory settings (or select your personal, customized picture settings.)
- 3. ANTENNA**  
Press to select "AIR" or "CABLE".
- 4. CHANNEL NUMBER**  
Press to directly tune to a particular channel.
- 5. -**  
Press to select additional channels (digital and analog) being broadcast by the same station. For example, to select channel "54-3", press "54", then press "-" and "3".
- 6. VOL +, VOL -**  
Press to increase or decrease the volume.
- 7. MUTE**  
Press to mute the TV sound.
- 8. Anynet**  
Runs the Anynet view functions and sets up Anynet devices. Please refer to the Anynet Owner's Instruction.
- 9. MENU**  
Displays the main on-screen menu.
- 10. CH.LIST**  
Displays the channel list.
- 11. FAV.CH (Favorite Channel)**  
Press to switch between your favorite channels.
- 12. MODE**  
Selects a target device to be controlled by the Samsung remote control (i.e., TV, STB, VCR, CABLE, or DVD).
- 13. PRE-CH**  
Tunes to the previous channel.
- 14. SOURCE**  
Press to display all of the available video sources (i.e., TV, Set-Top Box, VCR, DVD, DTV).
- 15. CH  $\wedge/\vee$**   
Press to change channels.  
Moves from one set of screen information to the next in TV Guide menu.

- 16. INFO**  
Press to display information on the TV screen.
- 17. EXIT**  
Press to exit the menu.
- 18.  $\blacktriangle$ ,  $\blacktriangledown$ ,  $\blacktriangleleft$ ,  $\blacktriangleright$ , ENTER**  
Press to select highlight up, down, left, or right. While using the on-screen menus, press ENTER to activate (or change) a particular item.
- 19. MTS (Multichannel Television Stereo)**  
Press to choose Stereo, Mono or SAP (Secondary Audio Program).
- 20. STILL**  
Press to pause the current screen.
- 21. P.SIZE**  
Press to change the screen size.
- 22. DNSe**  
DNSe enhances the sound quality, automatically controls output, and prevents sound distortion. Press this button to set it On or Off.
- 23. DNle (Digital Natural Image engine)**  
Activates DNle Demo mode.
- 24. SET**  
Used during set up of this remote control, so that it will work compatibly with other devices (some Samsung Set-top boxes, VCR, Cable box, DVD, etc.)
- 25. SLEEP**  
Press to select a preset time interval for automatic shut off.
- 26. CAPTION**  
Controls the caption decoder.
- 27. VCR/DVD Controls**  
Controls VCR or DVD functions: Rewind, Stop, Play/Pause, Fast Forward.
- 28. RESET**  
If your remote control is not functioning properly, take out the batteries and press the reset button for about 2~3 seconds. Re-insert the batteries and try using the remote control again.

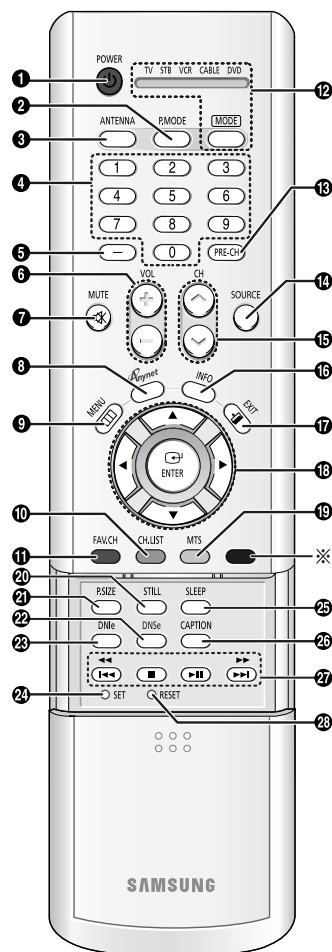

※ The blue button is only used during the channel list as an EXIT button.

# Your New Wide TV

## Installing Batteries in the Remote Control

With normal use, the batteries in the remote control should last about a year. If you notice a performance degradation while using the remote, the batteries may need to be replaced. Make sure you replace both batteries and do not mix old and new batteries in the remote control. If you won't be using the remote control for a long time, remove the batteries and store them in a cool dry place.

- 1 Slide the back cover all the way out to open the battery compartment of the remote control.

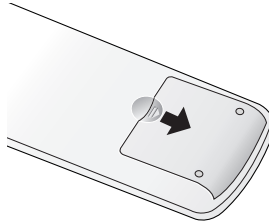

- 2 Install two AAA size batteries. Make sure to match the "+" and "-" ends of the batteries with the diagram inside the compartment.

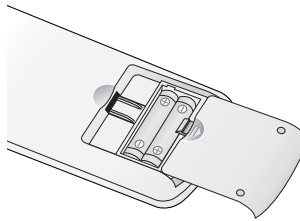

- 3 Slide the cover back into place.

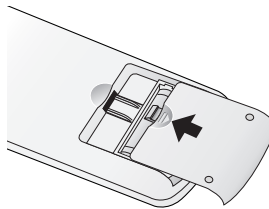

### **NOTE**

- Do not mix battery types, i.e., alkaline and manganese.



# Connections



# Connections

## Connecting VHF and UHF Antennas

If you do not have a cable system, you will need to connect an antenna to your TV.

### Antennas with 75-ohm Round Leads

If your antenna looks like this:  it has 75-ohm round leads.

- 1 Plug the antenna lead into the ANT 2 IN (AIR) on the rear panel of your TV.

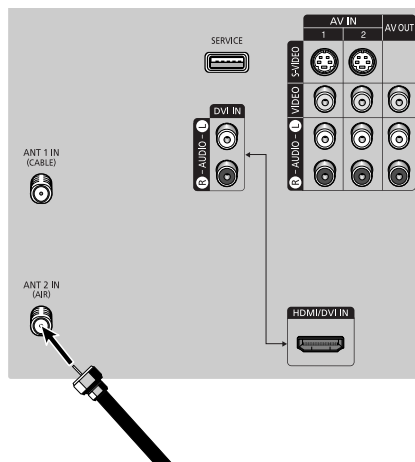



## Connecting Cable TV

You can connect different cable systems to your TV, including cable without a Cable box, and cable with a Cable box that descrambles some or all channels.

### Cable without a Cable Box

- 1 Plug the incoming cable into the ANT 1 IN (CABLE) on the rear panel of your TV.

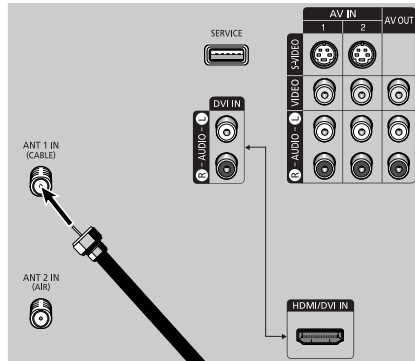

### Cable with a Cable Box that Descrambles All Channels

- 1 Find the cable connected to the ANTENNA OUT terminal on your Cable box. This terminal might be labeled "ANT OUT", "VHF OUT" or simply "OUT".

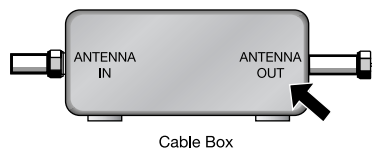

- 2 Connect the other end of the cable to the "ANT 1 IN (CABLE)" terminal on the rear panel of your TV.

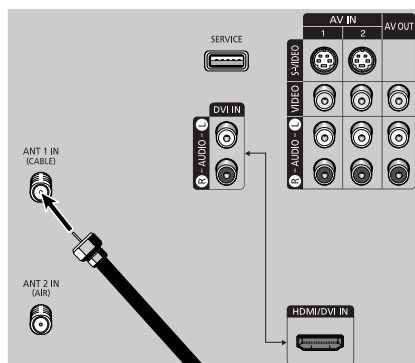

# Connections

## Cable with a Cable Box that Descrambles Some (But Not All) Channels

To complete this connection you will need a two-way splitter, an RF (A/B) switch, and four coaxial cables (which you can buy from your Samsung dealer or any electronics store).

- 1 Find and disconnect the cable that is connected to the ANTENNA IN terminal of your Splitter. This terminal might be labeled "ANT IN", "VHF IN" or simply, "IN". Connect this cable to a two-way splitter.



- 2 Connect a coaxial cable between an OUT terminal of the splitter and the IN terminal of the Cable box.

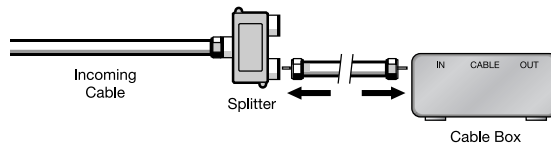

- 3 Connect a coaxial cable between the ANTENNA OUT terminal of the Cable box and the B-IN terminal of the RF (A/B) switch.

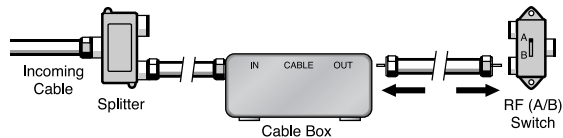

- 4 Connect a coaxial cable between the other OUT terminal of the Cable box and the A-IN terminal of the RF (A/B) switch.

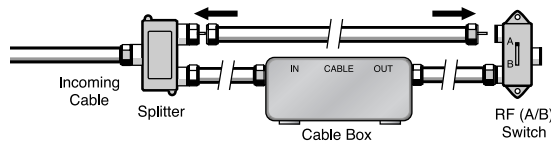

- 5 Connect the last coaxial cable between the OUT terminal of the RF (A/B) switch and the ANT 1 IN (CABLE) on the TV.

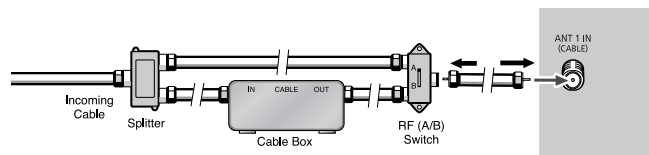

After you've made this connection, set the A/B switch to the "A" position for normal viewing. Set the A/B switch to the "B" position to view scrambled channels. (When you set the A/B switch to "B", you will need to tune your Set-Top Box to the Cable box's output channel, which is usually channel 3 or 4.)

# Connecting a VCR

## Connecting a VCR to the Video or S-Video/Audio jack

1 Connect the Video/Audio cables between the VIDEO or S-VIDEO/AUDIO input jacks on the TV and VIDEO or S-VIDEO/AUDIO output jacks on the VCR.

### NOTES

- For better video, use an S-Video cable.
- Please be sure to match the color coded input terminals and cable jacks.

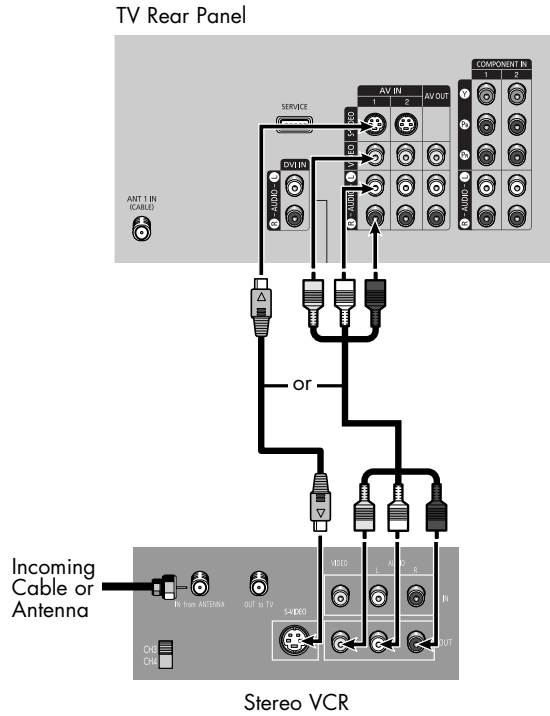

# Connections

## Connecting a Camcorder

The side panel jacks on your TV make it easy to connect a Camcorder to your TV. You can use your camcorder to view tapes without using a VCR.

1 Locate the A/V output jacks on the camcorder. They are usually found on the side or back of the camcorder.

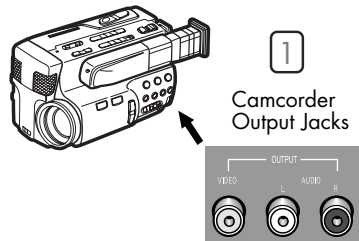

2 Connect a set of audio cables between the AUDIO IN jacks on the TV and the AUDIO OUT jacks on the camcorder. If you have a mono Camcorder, connect L(mono) to the Camcorder audio out using only one audio cable.

3 Connect a video cable between the VIDEO IN (or S-VIDEO IN) jack on the TV and the VIDEO OUT jack on the Camcorder. The audio-video cables shown here are usually included with a Camcorder. (If not, check your local electronics store.) If your Camcorder is stereo, you need to connect a set of two cables.

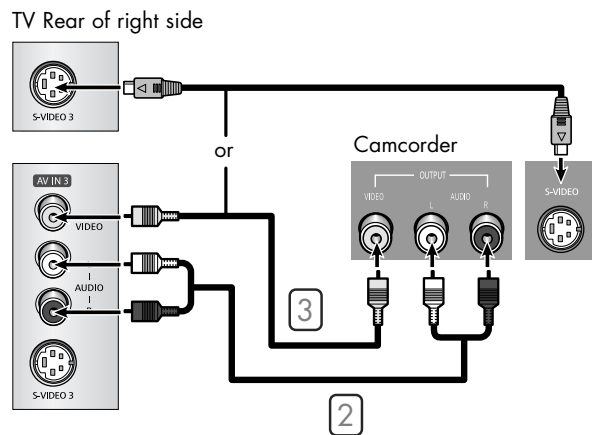

## Connecting a DVD Player

The rear panel jacks on your TV make it easy to connect a DVD player to your TV.

### Connecting to Y, Pb, Pr

- 1 Connect a set of audio cables between the COMPONENT (1 or 2) AUDIO (L, R) IN jacks on the TV and the AUDIO OUT jacks on the DVD player.
- 2 To enable Component video viewing, connect a set of video cables between the COMPONENT (1 or 2) VIDEO (Y, Pb, Pr) IN jacks on the TV and VIDEO (Y/Pb/Pr or Y/Cb/Cr) OUT jacks on the DVD player.

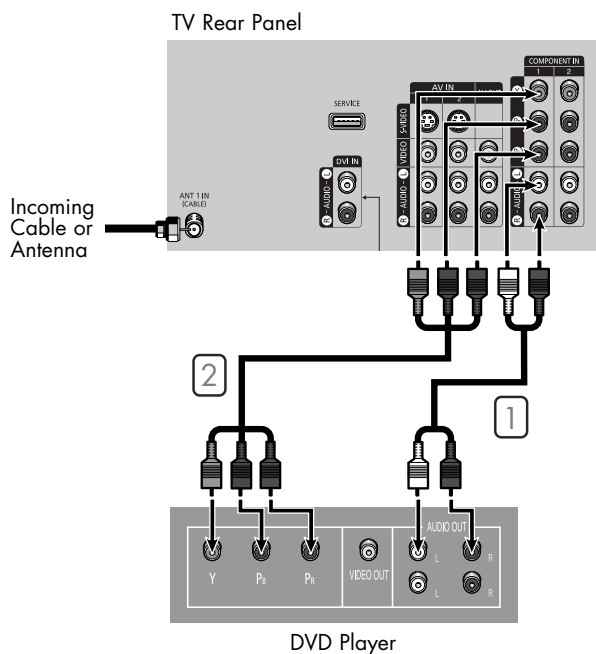

### Connecting to Audio and Video Jacks

- 1 Connect a set of audio cables between the AUDIO IN (1 or 2) jacks on the TV and the AUDIO OUT jacks on the DVD player.
- 2 Connect a video cable between the VIDEO IN (1 or 2) jack on the TV and the VIDEO OUT jack on the DVD player.

#### NOTE

- For an explanation of Component video, see your DVD player's owner's manual.

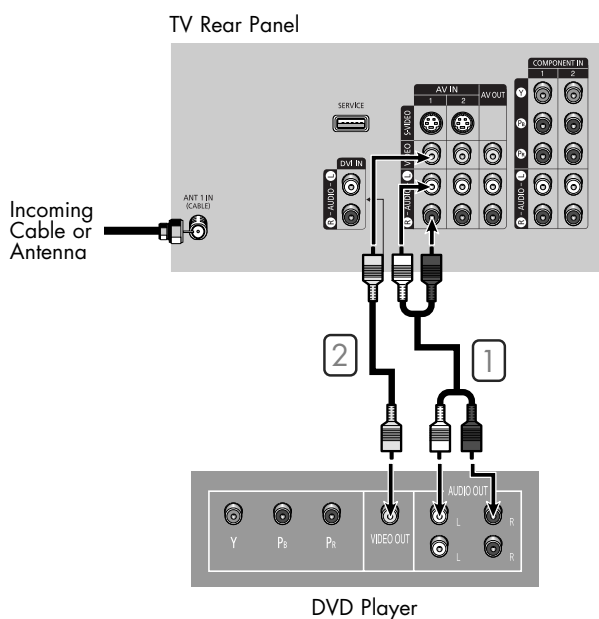

# Connections

## Connecting a DTV Set-Top Box

### Connecting to Y, Pb, Pr

- 1 Connect a set of audio cables between the COMPONENT (1 or 2) AUDIO (L, R) IN jacks on the TV and the AUDIO OUT jacks on the Set-Top Box.
- 2 Connect a set of video cables between the COMPONENT (1 or 2) VIDEO (Y, Pb, Pr) IN jacks on the TV and VIDEO (Y/Pb/Pr or Y/Cb/Cr) OUT jacks on the Set-Top Box.

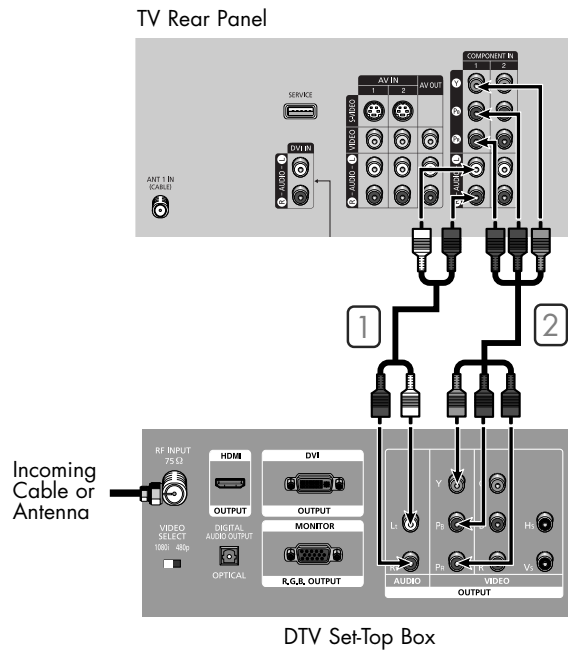

### Connecting to DVI (Digital Visual Interface)

- 1 Connect a set of audio cables between the DVI AUDIO (L, R) IN jacks on the TV and the AUDIO OUT jacks on the Set-Top Box.
- 2 Connect an HDMI/DVI video cable between the HDMI/DVI IN jack on the TV and the DVI OUT jack on the Set-Top Box.

### NOTES

- For an explanation of Component video, see your Set-Top Box owner's manual.
- Requires a Cable Converter.
- Make sure the DVI source's power is on, or you will be unable to select it in the TV menu's source list.

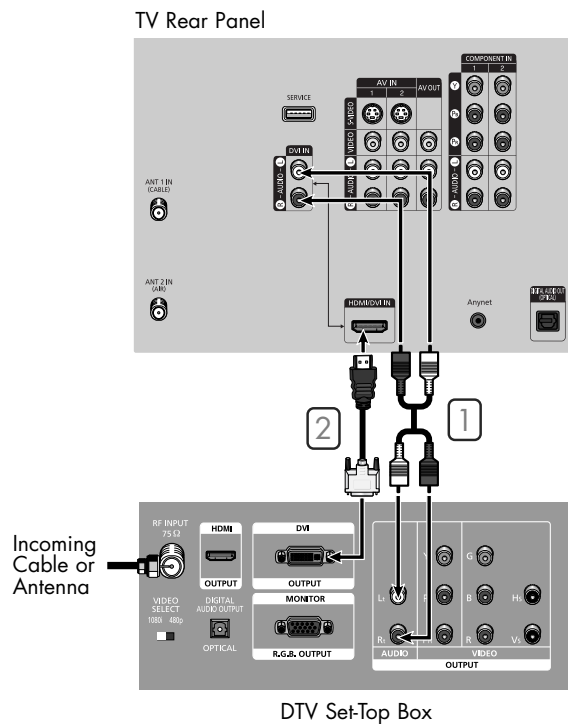

## Connecting to HDMI (High Definition Multimedia Interface)

- 1 Connect an HDMI cable between the HDMI/DVI IN jack on the TV and the HDMI OUT jack on the Set-Top Box.

### NOTE

- Make sure the HDMI/DVI source's power is on, or you will be unable to select it in the TV menu's source list.

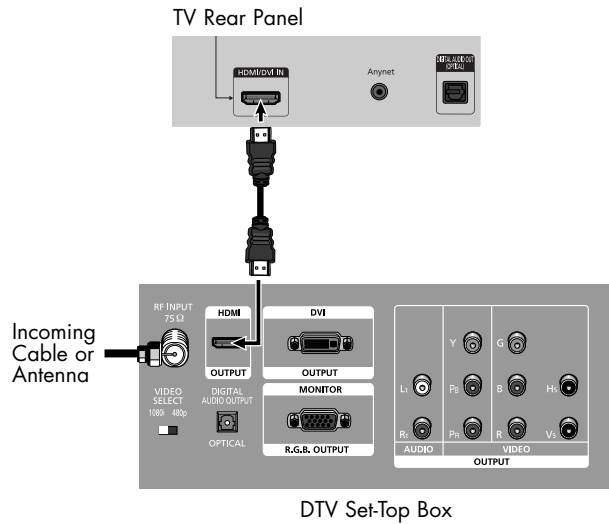

# Connections

## Connecting a Digital Audio System

There are many types of digital audio systems on the market today. A simplified illustration of an audio system is shown below. For more information, see your audio system owner's manual.

- 1 If your audio system has an optical digital audio input, connect to the "DIGITAL AUDIO OUT (OPTICAL)" jack on the TV.

### NOTE

- **OPTICAL:** converts the electric signal into an optical light signal, and transmits it through glass fibers. See page 67 to set the digital output format (Dolby Digital or PCM) appropriate to your digital audio component.

TV Rear Panel

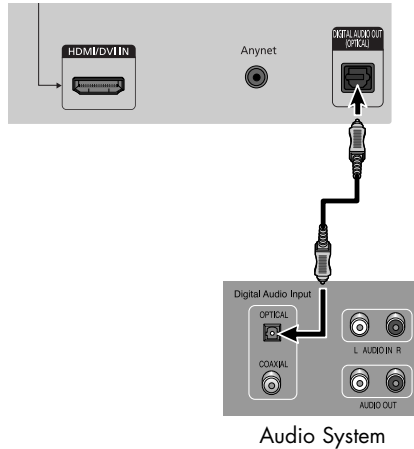

## Connecting to an Analog Amplifier

- 1 The "AUDIO OUT" terminals cannot be used for external speakers. You must hook them up to an amplifier. When an audio amplifier is connected to the "AUDIO OUT" terminals: Decrease the gain (volume) of the audio amplifier, set the internal mute on in the TV's Sound Menu and adjust the volume level with the volume control of the amplifier.

### NOTE

- If using the HDMI or Component input on the TV, the audio output signal is available only when the TV's Internal Mute is set to on. (Refer to page 68)

TV Rear Panel

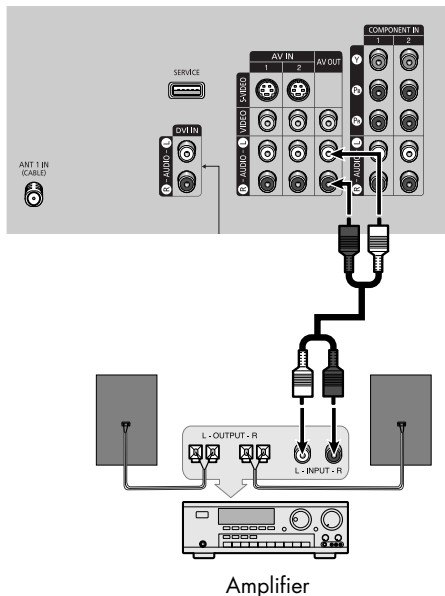





**Operation**

# Operation

## Turning the TV On and Off

Press the POWER button on the remote control.  
You can also use the POWER button on the front panel.

## Viewing the Menus and On-Screen Displays

The on-screen menu system allows you to control the settings of your TV. Access the on-screen menu system by pressing the MENU button on the remote control. Once the on-screen menu appears, use the ▲/▼/◀/▶/ENTER buttons on your remote control to select menu items and make adjustments. You can also view the on-screen menu system and make some adjustments using the TV's side panel buttons.

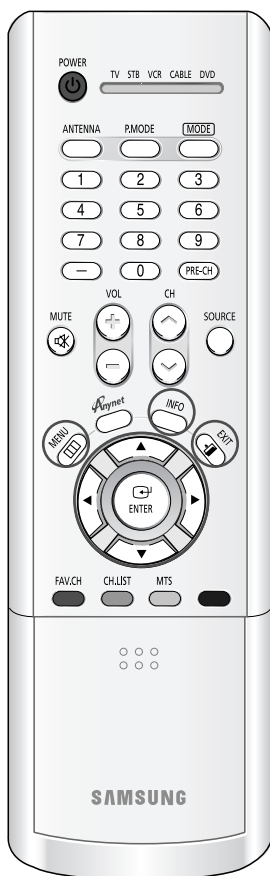

### Viewing the Menus

- 1 Press the MENU button.  
The main menu is displayed.  
There are six menu groups: "Input", "Picture", "Sound", "Channel", "Setup", and "Guide".

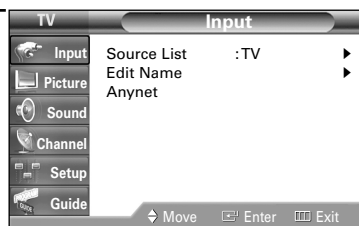

- 2 Press the ▲ or ▼ button to select an item you want in the menu.  
Press the ◀, ▶ or ENTER button to display, change, or use the selected items.  
Use the ENTER button to enter items in the menu.

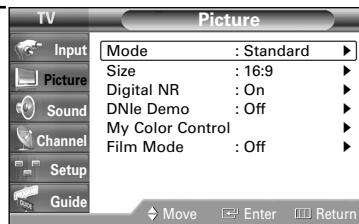

- 3 Press the EXIT button to exit.

### Viewing the Display

Press the INFO button on the remote control.  
The TV displays the current channel, the status of certain picture and sound settings and the current time.  
The information displayed varies according to the selected source.

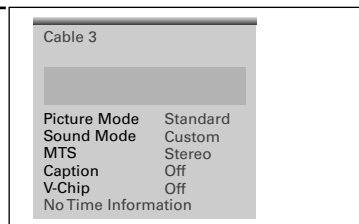

# Selecting a Menu Language

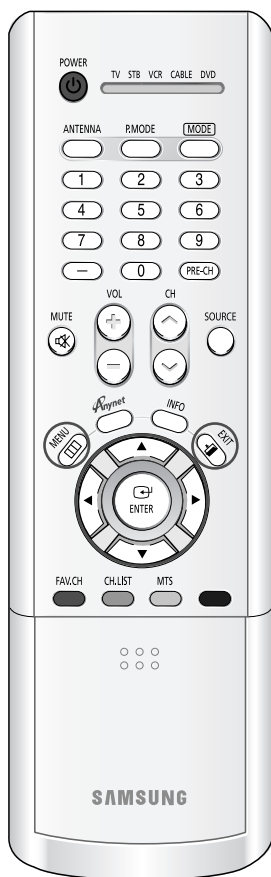

1 Press the MENU button.  
Press the ▲ or ▼ button to select "Setup", then press the ENTER button.

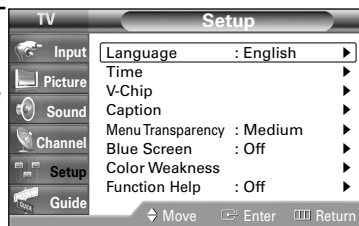

2 Press the ENTER button to select "Language".  
Press the ▲ or ▼ button to select "English", "Español" or "Français", then press the ENTER button.

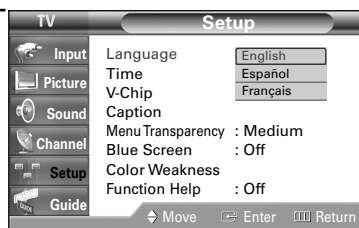

Press the EXIT button to exit.

# Operation

## Memorizing the Channels

Your TV can memorize and store all of the available channels for both “off-air” (antenna) and cable channels. After the available channels are memorized, use the CH  $\wedge$  and CH  $\vee$  buttons to scan through the channels. This eliminates the need to change channels by entering the channel digits. There are three steps for memorizing channels: selecting a broadcast source, memorizing the channels (automatic) and adding and deleting channels (manual).

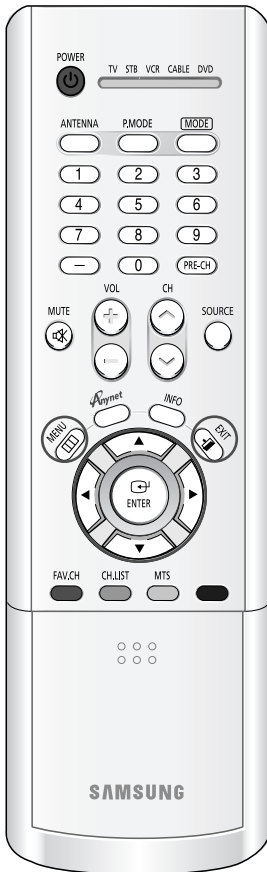

### Selecting the Video Signal Source

Before your television can begin memorizing the available channels, you must specify the type of signal source that is connected to the TV (i.e., an antenna or cable system).

- 1 Press the MENU button. Press the  $\blacktriangle$  or  $\blacktriangledown$  button to select “Channel”, then press the ENTER button.

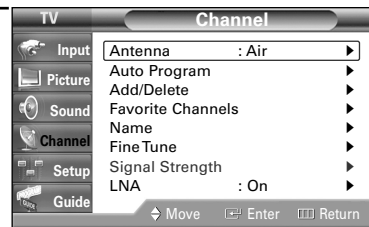

- 2 Press the ENTER button to select “Antenna”. Press the  $\blacktriangle$  or  $\blacktriangledown$  button to select “Air” or “Cable”, then press the ENTER button.

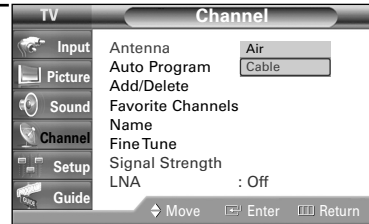

- 3 Press the  $\blacktriangle$  or  $\blacktriangledown$  button to select “Auto Program”, then press the ENTER button.

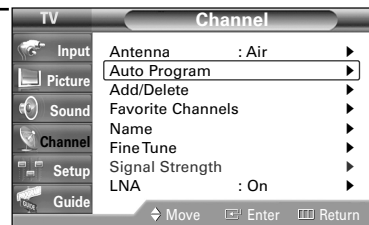

### NOTE

- All available DTV and analog channels are automatically stored in memory.

4 Press the ▲ or ▼ button to select the Antenna connection, then press the ENTER button.

- Air : "Air" antenna signal  
Cable : "Cable" antenna signal  
Air+Cable : "Air" and "Cable" antenna signals

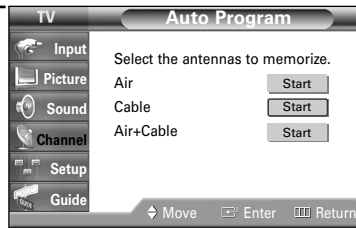

When selecting Cable TV system:  
Press the ENTER button to start the auto program. By default, the cable TV system is set to "STD".

If you want to select another type of cable system, press the ◀ button and use the ▲ or ▼ button to select Analog or Digital "STD", "HRC" or "IRC". Press the ENTER button.

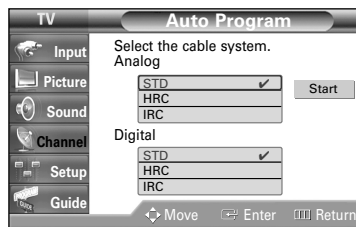

- STD, HRC and IRC identify various types of cable TV systems.  
Contact your local cable company to identify the type of cable system that exists in your particular area.  
At this point the signal source has been selected.

5 Press the ▶ button to select "Start", then press the ENTER button to start the auto program. The TV begins memorizing all available stations. Press the ENTER button at any time to interrupt the memorization process.

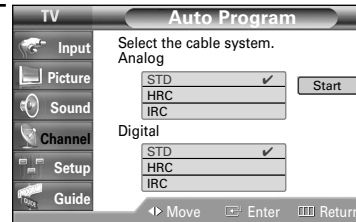

Press the EXIT button to exit.

- The TV must be connected to an antenna in order to receive digital TV signals. Even if a particular channel is deleted from the memory, you can always tune to that channel directly by using the number buttons on the remote control.

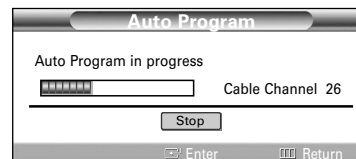

# Operation

## Adding and Erasing Channels

You can add channels that were not memorized (or delete unwanted channels from memory).



- 1 Press the MENU button.  
Press the ▲ or ▼ button to select "Channel", then press the ENTER button.

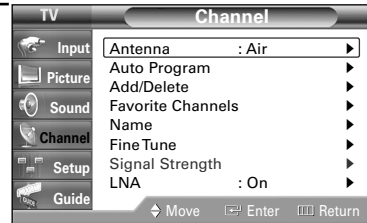

- 2 Press the ▲ or ▼ button to select "Add/Delete", then press the ENTER button.

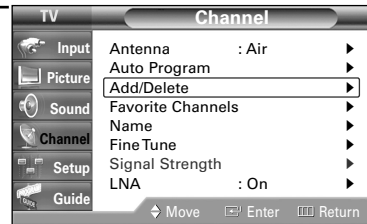

- 3 Repeatedly pressing the ENTER button will alternate between add channel and delete channel.  
Press the CH ▲ or CH ▼ button to switch to the appropriate channel, then repeat above.

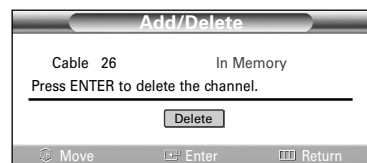

Press the EXIT button to exit.

# Changing Channels

## Using the Channel Buttons

Press the CH  $\wedge$  or CH  $\vee$  button to change channels.

When you press the CH  $\wedge$  or CH  $\vee$  button, the TV changes channels in sequence. You will see all the channels that the TV has memorized. (The TV must have memorized at least three channels.) You will not see channels that were either erased or not memorized.

## Using the Number Buttons

Use the number buttons to quickly switch to any channel.

Press the number buttons to go directly to a channel. For example, to select channel 27, press "2," then "7." The TV will change channels when you press the second number.

## Using the "-" Button

The "-" button is used to select stations that broadcast both a digital and analog signal.



### NOTE

- HD indicates the TV is receiving a Digital High Definition signal.  
SD indicates the TV is receiving an Analog standard definition signal.

For example, for channel 7-1 (digital), press "7", then "-", then "1", and you will see as right.

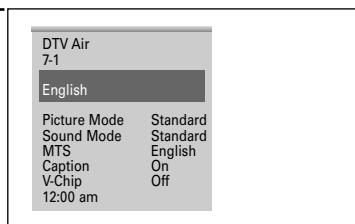

For channel 7-2 (analog), press "7", then "-", then "2", and you will see as right.

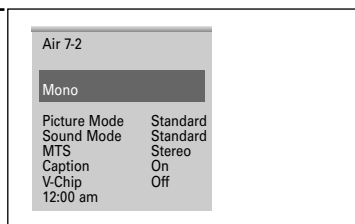

## Using the Previous Channel

Press the PRE-CH button. The TV changes to the last channel you were watching.

# Operation

## Customizing Your Remote Control

Your TV comes equipped with a universal remote control. In addition to controlling the TV, the universal remote control can also operate a VCR, Cable box, DVD, and some Samsung Set-top boxes (even if your VCR, Cable box and DVD are made by manufacturers other than Samsung).

### NOTE

- The remote control might not be compatible with all DVD Players, VCRs, Cable boxes, and Set-Top Boxes.



### Setting Up Your Remote Control to Operate Your VCR (Cable box or DVD player)

- 1 Turn off your VCR (Cable box or DVD player).
- 2 Press the MODE button to switch the remote control to the VCR (CABLE or DVD) mode.  
The remote control has five modes: TV, STB, VCR, CABLE, and DVD.
- 3 On your Samsung remote control, press the SET button.
- 4 Enter 3 digits of the VCR (Cable box or DVD player) code listed on next page for your brand of VCR (Cable box or DVD player). Make sure you enter 3 digits of the code, even if the first digit is a "0". (If more than one code listed, try the first one.)
- 5 Press the POWER button. Your VCR (Cable box or DVD player) should turn on. If your VCR (Cable box or DVD player) turns on, your remote control is now set correctly.  
If your VCR (Cable box or DVD player) does not turn on, repeat steps 2, 3, and 4, but try one of the other codes listed for the brand of your particular VCR (Cable box or DVD player).
- 6 Once your remote control is set up, press the MODE button any time you want to use the remote to operate your VCR (Cable box or DVD player).

### NOTES

- When your remote is in the TV mode, the VCR (or DVD player) control buttons (REW, STOP, PLAY/PAUSE, and FF) will still operate your VCR (or DVD player).
- When your remote control is in the STB, VCR, CABLE, or DVD mode, the volume buttons still control your TV's volume.



# Remote Control Codes

## VCR Codes

Admiral	015,088	Hitachi	014,024,044,045	Quasar	017,053
Aiwa	024	Instant Replay	017	Radio Shack	011,015,017,018,021,024,028,036,052,062
Akai	026,031,032	JC Penny	011,014,016,017,023,025,039,044,060,062	RCA	009,014,016,017,037,044,046,063,078
Audio Dynamics	022,025	JCL	011,017,023,025,039,055	Realistic	011,015,017,018,021,024,028,036,052,062
Bell & Howell	011	Kenwood	011,023,025,039,055	Samsung	000,016,022,031,041,051
Broksonic	019	KLH	082	Sansui	025
Candle	016,018,022,054,055,061	LG(Goldstar)	001,002,007,018,023,055,069	Sanyo	011,021
Canon	017,062	Lloyd	024	Scott	022,050,058,077
Citizen	016,018,022,054,055,061	Logik	040	Sears	011,014,018,021,027,028,044,052,057
Colorlyme	023	LXI	024	Sharp	015,036,048,054
Craig	016,021	Magnavox	017,038,062,065	Shintom	026,035,040,064
Curtis Mathes	009,016,017,023,024,055,062,073,076	Marantz	011,017,023,025,038,039,055,070	Signature	024
Daewoo	003,004,005,006,007,008,022,054,085	MTC	016,024	Sony	026,035,047
DB	023,025	Multitech	016,024,040,041	Sylvania	017,024,038,062,065
Dimensia	009	NEC	011,023,025,039,055,070,073	Symphonic	024
Dynatech	024	Optimus	015	Tandy	011,024
Electrohome	036	Panasonic	017,062,084,086	Tatung	039
Emerson	017,018,019,022,024,029,032,036,043,050,051,056,058,066,071,074,076,077,079	Pentax	014,044	Teac	024,039,078
Fisher	011,021,027,028,052,057,067	Pentex Research+	055	Technics	017
Funai	024	Philco	017,038,062,065	Teknika	017,018,024,030
General Electric	009,016,017,041,062	Philips	017,038	TMK	076
Go Video	016	Pioneer	014,025,042,059	Toshiba	014,022,028,057,058
Harman Kardon	023	Portland	053,054,061	Toshiko	018
		PROSCAN	009	Totevision	016,018
		Quartz	011		

## Cable Box Codes

Anvision	015,016	Magnavox	015,016,027,029,034,036,037,040,041,048,049	Signature	054
Cable Star	015,016	Nawoo	001	Sprucer	035
DaeHan	005	NSC	017	Starcom	054
DeaRyung	003	Oak	024,046	Stargate2000	066
DongKuk	004	Osk Sigma	024	Sylvania	019,067
Eagle	015,016	Panasonic	011,035,047,069	TaePyungYang	002
Eastern International	020	Philips	015,016,027,029,034,036,037,040,041,048,049	Texscan	019,067
General Instrument	054	Pioneer	026,028,052	Tocom	025,029,057,058,063
GI	012,013,023,031,032,033,038,044,075,076,077	Randtek	015,016	Unika	039,040,049
Hamlin	011,012,020,021,042,056	RCA	008,035,074	Universal	059,060
Hitachi	045,051,054	Regal	011,020,021	Viewstar	015,016,027,029,034,036,037,040,041,048,049
Jerrold	012,013,023,031,032,033,038,044,054,070,073	Regency	010,041	Warner Amex	052
LG(Goldstar)	006	Saewoo	007	Zenith	022,050,065,069
Macom	045,051	Samsung	000,011,030,052,071,072		

## DVD Codes

Curtis Mathes	009	Philips	007	Sharp	005
JVC	003	PROSCAN	008	Sony	004
LG(Goldstar)	001	RCA	008	Toshiba	002
Panasonic	006	Samsung	000		

# Operation

## Setting the Clock

Setting the clock is necessary in order to use the various timer features of the TV. Also, you can check the time while watching the TV. (Just press the INFO button.)



### Option 1: Setting the Clock Manually

- 1 Press the MENU button. Press the ▲ or ▼ button to select "Setup", then press the ENTER button.

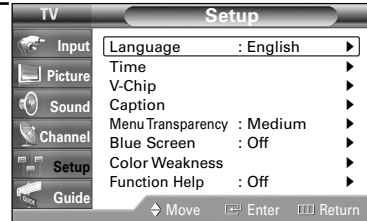

- 2 Press the ▲ or ▼ button to select "Time", then press the ENTER button. Press the ENTER button to select "Clock".

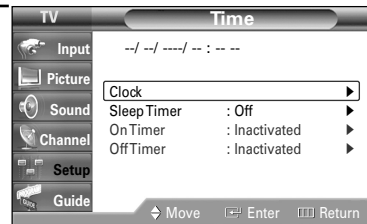

- 3 Press the ENTER button to select "Clock Mode". Press the ▲ or ▼ button to select "Manual", then press the ENTER button.

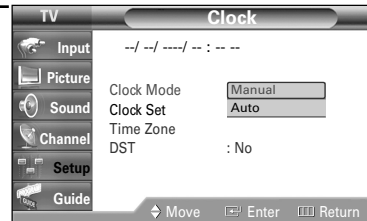

- 4 Press the ▲ or ▼ button to select "Clock Set", then press the ENTER button.

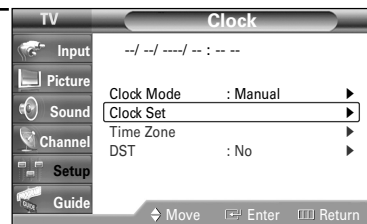

- 5 Press the ◀ or ▶ button to move to "Month", "Day", "Year", "Hour", "Minute", or "am/pm". Set the clock you want by pressing the ▲ or ▼ button, then press the ENTER button.

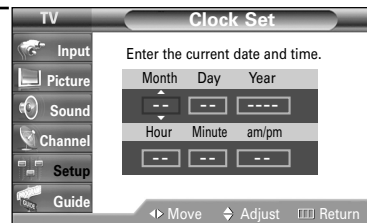

- You can set the month, day, year, hour and minute directly by pressing the number buttons on the remote control.

Press the EXIT button to exit.

### NOTE

- The current time will appear every time you press the INFO button.

## Option 2: Setting the Clock Automatically

The Clock can be set automatically if you are receiving a digital signal.

- 1 Press the MENU button.  
Press the ▲ or ▼ button to select "Setup", then press the ENTER button.

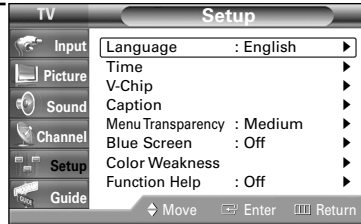

- 2 Press the ▲ or ▼ button to select "Time", then press the ENTER button.  
Press the ENTER button to select "Clock".

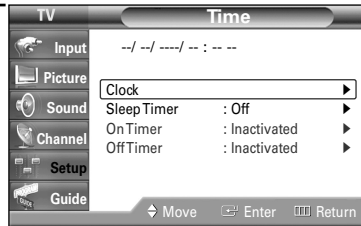

- 3 Press the ENTER button to select "Clock Mode".  
Press the ▲ or ▼ button to select "Auto", then press the ENTER button.

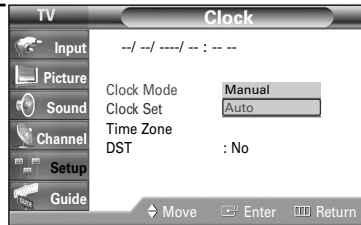

- 4 Press the ▲ or ▼ button to select "Time Zone", then press the ENTER button.

Press the ▲ or ▼ button to highlight the time zone for your local area (and to move the highlight to the appropriate time zone on the map of the United States), then press the ENTER button.

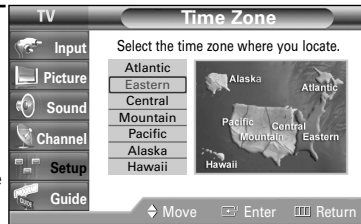

- When you set up Auto Time, the set time may not be correct depending on the broadcasting station and signal. If there is a difference between the real time and set time, please set the time manually.

- 5 Press the ▲ or ▼ button to select "DST"(Daylight Saving Time), then press the ENTER button.  
Press the ▲ or ▼ button to select "Yes" or "No", then press the ENTER button.

Press the EXIT button to exit.

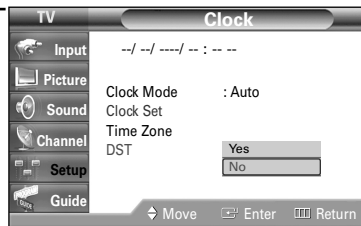

# Operation

## Setting the On/Off Timer



### NOTE

#### • **Auto Power Off**

When you set the timer "On", the television will eventually turn off, if no controls are operated for 3 hours after the TV was turned on by the timer. This function is only available in timer "On" mode and prevents overheating or leakage, which may occur if a TV is on for too long (when you are on vacation, for example).

- 1 Press the MENU button.  
Press the ▲ or ▼ button to select "Setup", then press the ENTER button.

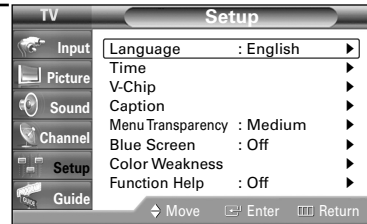

- 2 Press the ▲ or ▼ button to select "Time", then press the ENTER button.  
Press the ▲ or ▼ button to select "On Timer", then press the ENTER button.  
Press the ▲ or ▼ button to adjust "Hour", then press the ► button to move to the next step.  
Set other items using the same method as above.

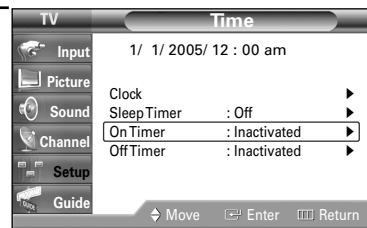

To activate On Timer with the setting entered, set Activation to "Yes" by pressing ▲ or ▼ button.

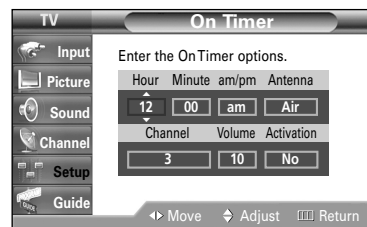

- You can set the hour, minute, channel, and volume directly by pressing the number buttons on the remote control.

When finished, press the MENU button to return.

- 3 Press the ▲ or ▼ button to select "Off Timer", then press the ENTER button.  
Press the ▲ or ▼ button to adjust "Hour", then press the ► button to move to the next step. Set other items using the same method as above.

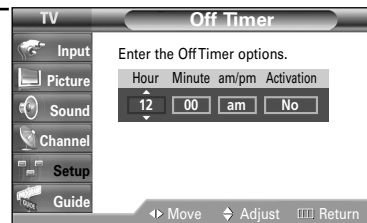

To activate Off Timer with the setting entered, set Activation to "Yes" by pressing ▲ or ▼ button.

When finished, press the EXIT button to exit.

# Setting the Sleep Timer

The sleep timer automatically shuts off the TV after a preset time (from 30 to 180 minutes).



1 Press the MENU button. Press the ▲ or ▼ button to select "Setup", then press the ENTER button.

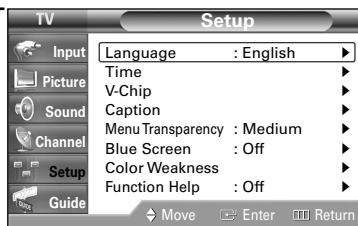

2 Press the ▲ or ▼ button to select "Time", then press the ENTER button. Press the ▲ or ▼ button to select "Sleep Timer", then press the ENTER button.

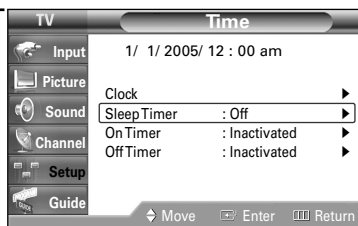

3 Press the ▲ or ▼ button to adjust "Minute".

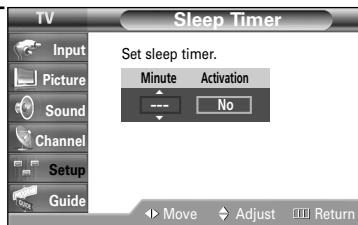

4 Setting the Timer sets the Activation to "Yes" automatically.

Press the EXIT button to exit.

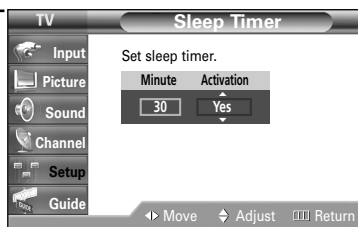

## Alternate method

Press the SLEEP button under the remote's cover repeatedly until the appropriate time interval appears (any of the preset values from "30 min" to "180 min").

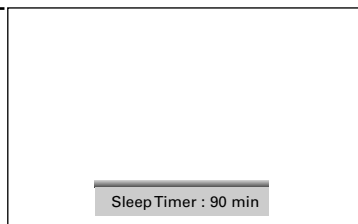

# Operation

## Viewing an External Signal Source

Use the remote control to switch between viewing signals from connected equipment, such as a VCR, DVD, Set-Top Box or the TV source (broadcast or cable).



### Setting the Signal Source

- 1 Press the MENU button.  
Press the ENTER button to select "Input".

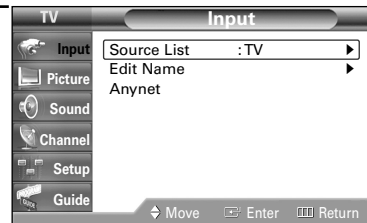

- 2 Press the ENTER button to select "Source List".  
Press the ▲ or ▼ button to select a signal source, then press the ENTER button.

- When you connect equipment to the TV, you can choose between the following sets of jacks: "AV1", "AV2", "S-VIDEO1", "S-VIDEO2", "COMPONENT1", "COMPONENT2", or "HDMI/DVI" on the TV's rear panel and "AV3" or "S-VIDEO3" on the TV's side panel.

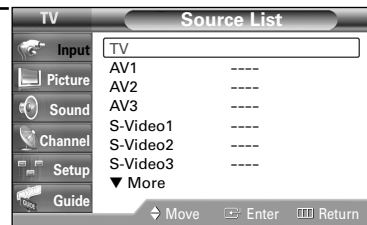

### Alternate method

Press the SOURCE button on the remote control repeatedly to select an external signal source.

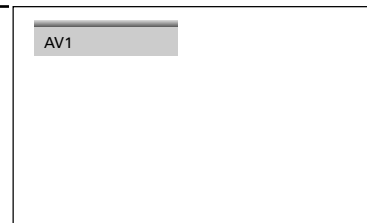

### NOTES

- Before selecting an input source, connect an external device first.
- HDMI input can be selected only when the external device is turned on and connected to the TV.

# Assigning Names to External Input Mode

This feature enables you to name the input source you have connected.

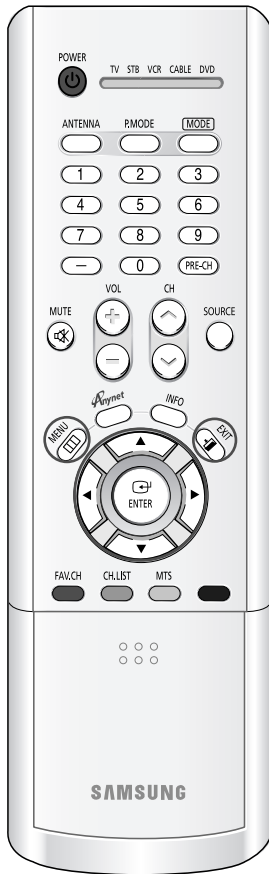

1 Press the MENU button.  
Press the ENTER button to select "Input".

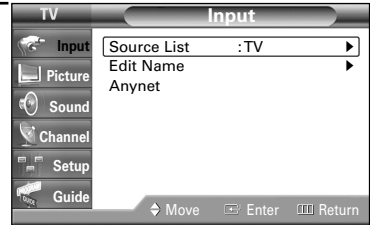

2 Press the ▲ or ▼ button to select "Edit Name", then press the ENTER button.

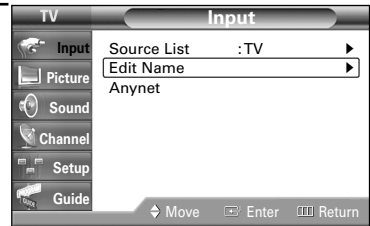

3 Press the ▲ or ▼ button to select a signal source to edit, then press the ENTER button.

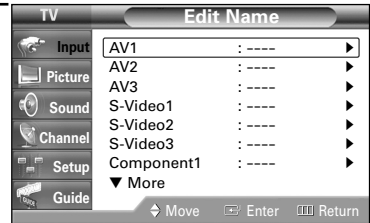

4 Press the ▲ or ▼ button to select the external device : VCR, DVD, D-VHS, Cable STB, HD STB, Satellite STB, PVR STB, AV Receiver, DVD Receiver, GAME, Camcorder, DVD Combo, DVD HDD Recorder, Internet TV Recv., Interactive TV Recv., VOD (Video On Demand) STB, TV.

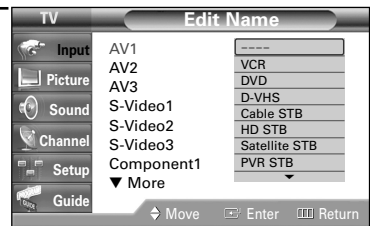

Press the ENTER button.  
Set other signal sources (AV2, AV3, S-Video 1, S-Video2, S-Video3, Component1, Component2, HDMI) using the same method as listed above.

Press the EXIT button to exit.

---

SAMSUNG





# **Channel Control**



# Channel Control

## Selecting Your Favorite Channels

You can store your favorite channels for each available input source (such as TV and CATV). This allows you to quickly and easily find frequently watched channels by pressing the FAV.CH button on the remote control.



### To Store Your Favorite Channels:

- 1 Press the MENU button. Press the ▲ or ▼ button to select "Channel", then press the ENTER button.

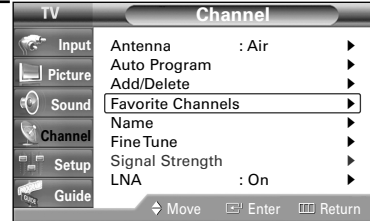

- 2 Press the ▲ or ▼ button to select "Favorite Channels", then press the ENTER button. Press the ▲ or ▼ button to select a channel, then press the ENTER button and a check mark will appear. Press the ENTER button again to deselect the selected channel and the check mark will disappear.

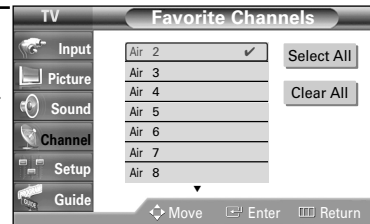

Press the EXIT button to exit.

### NOTES

- Only memorized channels can be set as Favorite channels.
- Select All : Press to select all channels.
- Clear All : Press to clear all channels.

### To View Your Favorite Channels:

Press the FAV.CH button repeatedly to jump from one favorite channel to another.

## Labeling the Channels

Use this feature to assign an easy-to-remember label to analog channels (i.e., "CBS", "ESPN", "PBS2", CNN02", etc.) A label consists of five fields, where each field is a letter, a number or a blank. When the INFO button is pressed, the channel label will appear below to the channel number.

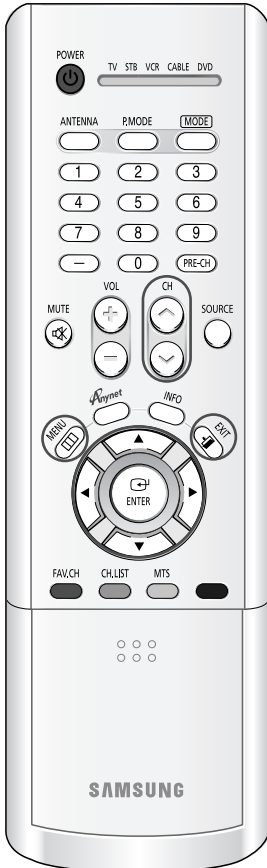

1 Press the CH  $\wedge$  or CH  $\vee$  button to tune to the channel that will be labeled.

2 Press the MENU button. Press the  $\blacktriangle$  or  $\blacktriangledown$  button to select "Channel", then press the ENTER button. Press the  $\blacktriangle$  or  $\blacktriangledown$  button to select "Name", then press the ENTER button.

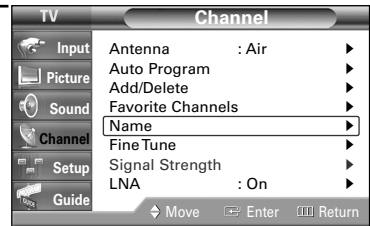

3 Press the  $\blacktriangle$  or  $\blacktriangledown$  button to move to the channel to be assigned to a new name, then press the ENTER button. Press the  $\blacktriangle$  or  $\blacktriangledown$  button to select a letter, a number or a blank. (Results in this sequence: A...Z, 0...9, +, -, \*, /, blank).

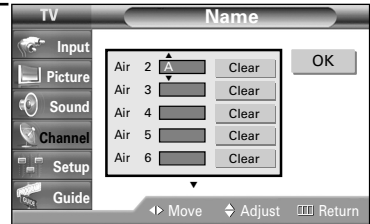

4 Press the  $\blacktriangleright$  button to switch to the next field, which will be selected. Select a second letter or digit pressing  $\blacktriangle$  or  $\blacktriangledown$  button, as above. Repeat the process to select the last three digits.

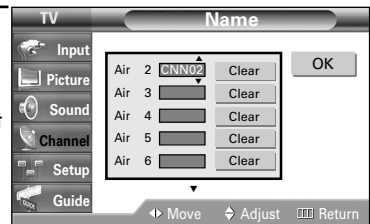

### NOTE

- If you add or delete a TV channel, the labeled channels will also be added or deleted.

After all settings are completed, select OK using the  $\blacktriangleright$  button. Press the ENTER button to save the settings and return to the previous menu.

To erase the assigned new name, select "Clear" by pressing the  $\blacktriangleleft$  or  $\blacktriangleright$  button, then press the ENTER button.

Press the EXIT button to exit.

# Channel Control

## Fine Tuning Analog Channels **Analog**

Use fine tuning to manually adjust a particular channel for optimal reception.



### NOTE

- Only analog TV channels can be fine tuned.

- 1 Press the MENU button.  
Press the ▲ or ▼ button to select "Channel", then press the ENTER button.

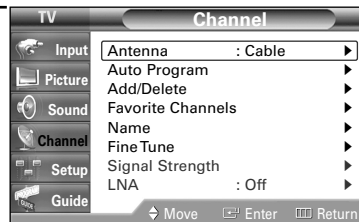

- 2 Press the ▲ or ▼ button to select "Fine Tune", then press the ENTER button.

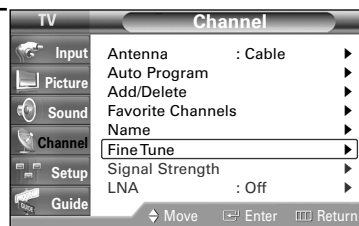

- 3 Press the ◀ or ▶ button to adjust the fine tuning.

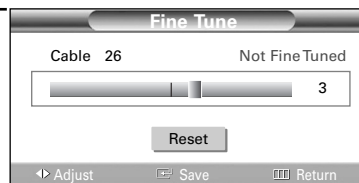

- 4 To store the fine tuning setting in the TV's memory, press the ENTER button. To reset the fine tuning setting, press the ▼ button to select "Reset", then press the ENTER button.

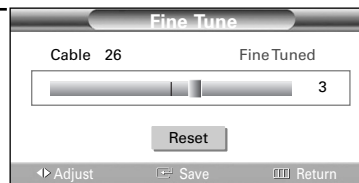

- 5 Press the EXIT button to exit.

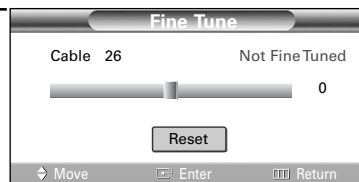

## Checking the Digital-Signal Strength Digital

Unlike analog channels, which can vary in reception quality from “snowy” to clear, digital (HDTV) channels have either perfect reception quality or you will not receive them at all. So, unlike analog channels, you cannot fine tune a digital channel.

You can, however, adjust your antenna to improve the reception of available digital channels.



- 1 Press the MENU button.  
Press the ▲ or ▼ button to select “Channel”, then press the ENTER button.

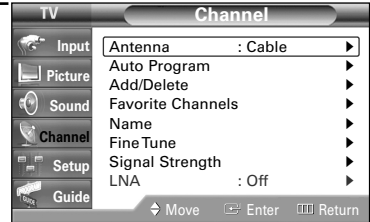

- 2 Press the ▲ or ▼ button to select “Signal Strength”, then press the ENTER button.

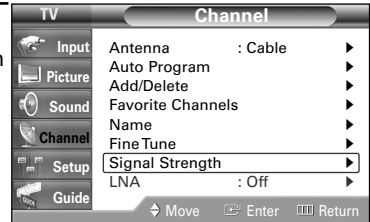

If the signal strength meter indicates that the signal is weak, physically adjust your antenna to increase the signal strength. Continue to adjust the antenna until you find the best position with the strongest signal.

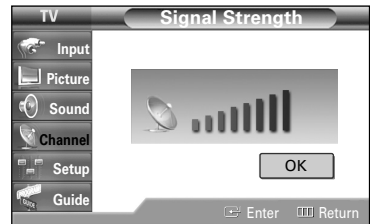

Press the EXIT button to exit.

# Channel Control

## LNA (Low Noise Amplifier)

If the TV is operating in a weak-signal area, sometimes the LNA function can improve the reception (a low-noise preamplifier boosts the incoming signal).



1 Press the MENU button.  
Press the ▲ or ▼ button to select "Channel", then press the ENTER button.

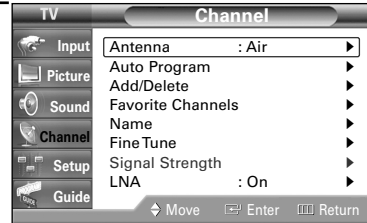

2 Press the ▲ or ▼ button to select "LNA", then press the ENTER button.

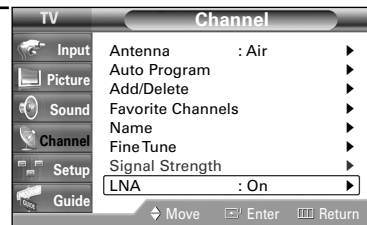

3 Press the ▲ or ▼ button to select "On" or "Off", then press the ENTER button.

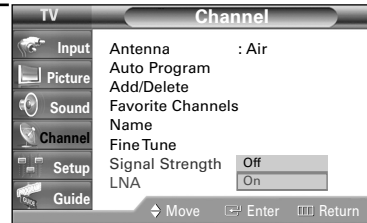

4 Press the EXIT button to exit.

### NOTES

- LNA functions only when antenna is set to Air.  
The settings will be stored separately in each channel.
- If the picture is noisy with the LNA set to On, select Off.
- The LNA setting must be made separately for each channel.



# Picture Control



# Picture Control

## Picture Control

You can select the type of picture which best corresponds to your viewing requirements.



### Changing the Picture Standard

- 1 Press the MENU button.  
Press the ▲ or ▼ button to select "Picture", then press the ENTER button.

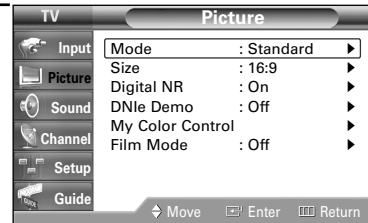

- 2 Press the ENTER button again to select "Mode".

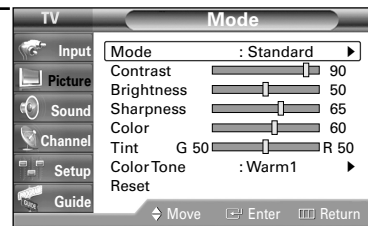

- 3 Press the ENTER button.  
Press the ▲ or ▼ button to select the desired picture mode (Dynamic, Standard, Movie, Custom), then press the ENTER button.

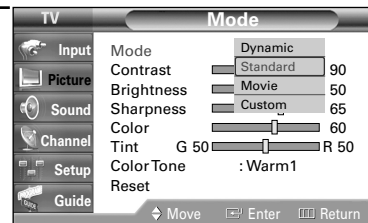

Press the EXIT button to exit.

### Alternate method

Press the P.MODE button on the remote control repeatedly to select the desired picture mode.

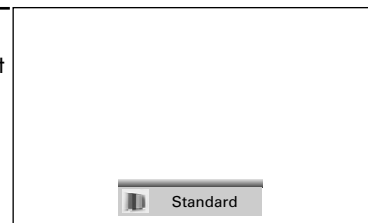

- Choose "Dynamic" for viewing the TV during the day or when there is a bright light in the room.
- Choose "Standard" for the standard factory settings.
- Choose "Movie" when viewing a movie.
- Choose "Custom" if you want to adjust the settings according to personal preference (see "Customizing the Picture Settings", page 49).



## Customizing the Picture Settings

You can use the on-screen menus to change the "Contrast", "Brightness", "Sharpness", "Color", "Tint", and "Color Tone" according to personal preference. You can select "Standard" which automatically recalls your personalized picture settings.



- 1 Press the MENU button. Press the ▲ or ▼ button to select "Picture", then press the ENTER button.

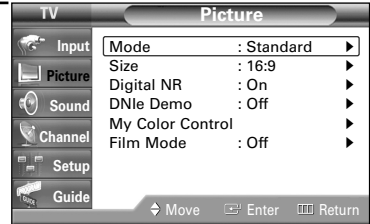

- 2 Press the ENTER button to select "Mode".

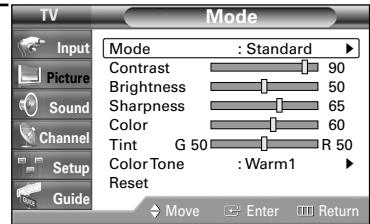

- 3 Press the ENTER button. Press the ▲ or ▼ button to select the desired picture mode (Dynamic, Standard, Movie, Custom), then press the ENTER button.

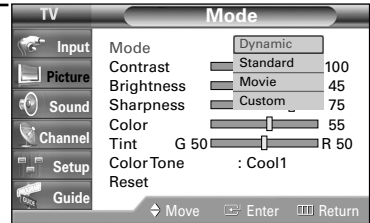

- 4 Press the ▲ or ▼ button to select a particular option (Contrast, Brightness, Sharpness, Color, or Tint), then press the ENTER button.

Press the ◀ or ▶ button to decrease or increase the value of a particular item.

- You can also select these options (Contrast, Brightness, Sharpness, Color, or Tint) by pressing the ▲ or ▼ button.

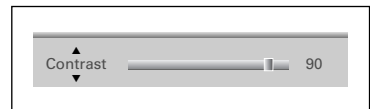
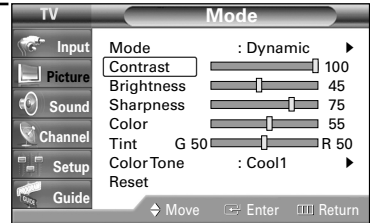

### NOTES

- "Tint" doesn't operate in HDMI or 480p Component or higher modes.
- The Tint cannot be adjusted while watching Digital TV.

Continued...

# Picture Control

- 5 Press the ENTER button to return to "Mode".  
Press the ▲ or ▼ button to select "Color Tone", then press the ENTER button.

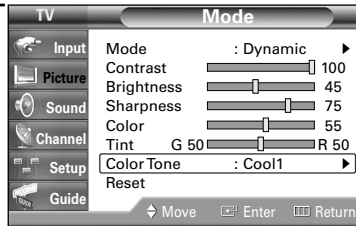

- 6 Press the ▲ or ▼ button to select a particular option (Cool2, Cool1, Normal, Warm1, or Warm2), then press the ENTER button.

Press the EXIT button to exit.

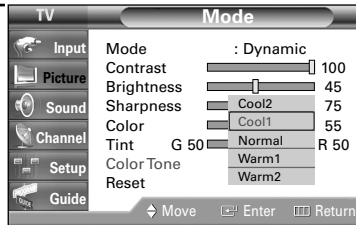

## NOTE

- Color tone is not available in the "Movie" picture mode.

## Resetting the Picture Settings to the Factory Defaults

- 7 To return the factory defaults, select "Reset" by pressing the ▲ or ▼ button. Press the ENTER button.

- The previously adjusted settings will be reset to the factory defaults.

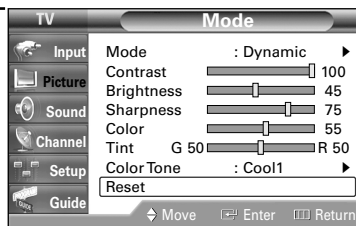

# Changing the Picture Size

You can select the picture size which best corresponds to your viewing requirements.



1 Press the MENU button.  
Press the ▲ or ▼ button to select "Picture", then press the ENTER button.  
Press the ▲ or ▼ button to select "Size", then press the ENTER button.

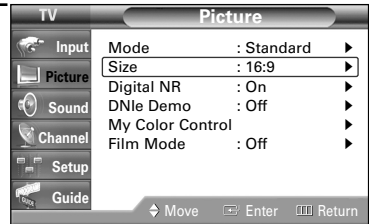

2 Press the ◀ or ▶ button to select the screen format you want, then press the ENTER button.

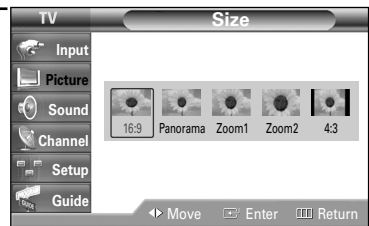

Press the EXIT button to exit.

## Alternate method

Press the P.SIZE button under the remote's cover repeatedly to select one of the picture size settings.

- "16:9": Sets the picture to 16:9 wide mode.
- "Panorama": Sets the picture to the wide aspect ratio of a panoramic picture.
- "Zoom1": Magnifies the size of the picture on screen.
- "Zoom2": Magnifies the size of the picture more than "Zoom1".
- "4:3": Sets the picture to 4:3 normal mode.  
This is a standard TV screen size.

## NOTES

- You can select only the 16:9 and 4:3 screen sizes in the DTV or Component (720p, 1080i) mode.
- For Zoom1 and Zoom2, you can adjust the size by using the ▲ or ▼ button after pressing the P.SIZE button under the remote's cover.

# Picture Control

## Digital Noise Reduction

If the broadcast signal received by your TV is weak, you can activate the Digital Noise Reduction feature to help reduce any static and ghosting that may appear on the screen.

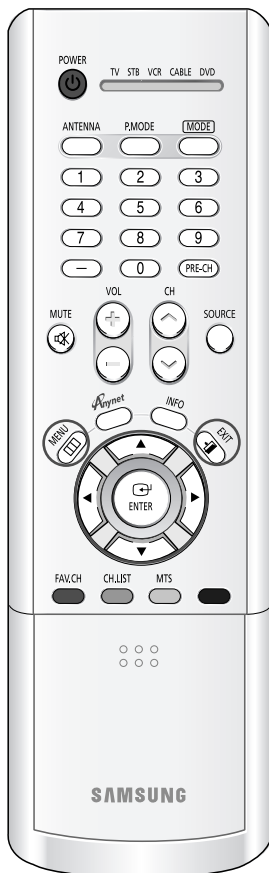

- 1 Press the MENU button.  
Press the ▲ or ▼ button to select "Picture", then press the ENTER button.

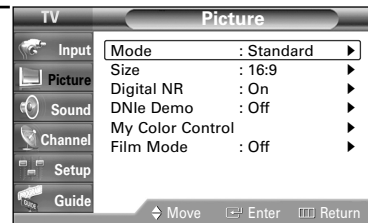

- 2 Press the ▲ or ▼ button to select "Digital NR", then press the ENTER button.

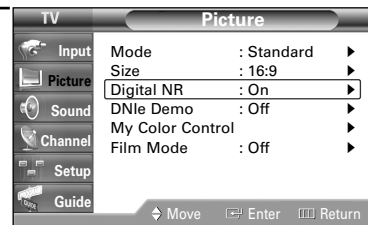

- 3 Press the ▲ or ▼ button to select "Off" or "On", then press the ENTER button.

Press the EXIT button to exit.

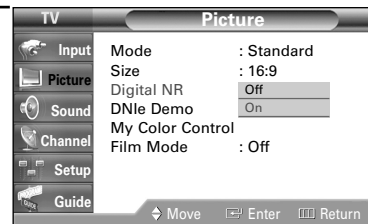

## Viewing the DNle Demonstration

This TV includes the DNle function so as to provide a high visual quality. If you set DNle Demo to On, you can view an applied DNle and normal picture on the screen simultaneously, for demonstration purposes. Using this function, you can view the difference in the visual quality.



- 1 Press the MENU button.  
Press the ▲ or ▼ button to select "Picture", then press the ENTER button.

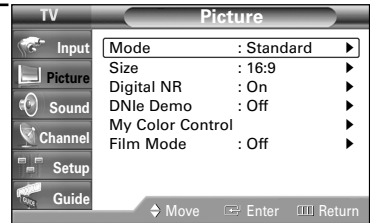

- 2 Press the ▲ or ▼ button to select "DNle Demo", then press the ENTER button.

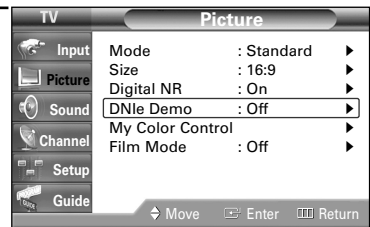

- 3 Press the ▲ or ▼ button to select "Off" or "On", then press the ENTER button.

Press the EXIT button to exit.

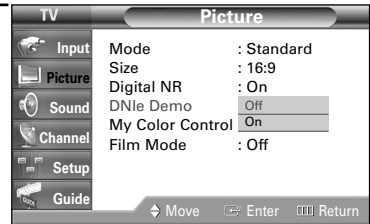

### Alternate method

Press the DNle button under the remote's cover repeatedly to select one of the settings.

- On: Switches on the DNle Demo mode.
- Off: Switches off the DNle Demo mode.

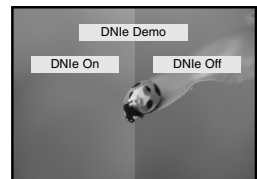

### NOTE

- DNle™ (Digital Natural Image engine) **DNle™**  
This feature brings you a more detailed image with 3D noise reduction and detail, contrast and white enhancement.

# Picture Control

## Setting the My Color Control Mode

My Color Control allows you to adjust colors according to your preference, by adjusting skin, sky, and grass tones using the predefined settings ("Blue", "Green", "Pink", "Standard", and "Custom") without affecting other colors on the screen.



### NOTE

- Changing the settings in the "Detail Control" menu (see next page) will automatically set the My Color Control mode to "Custom".

### Using the Easy Control Menu

1 Press the MENU button. Press the ▲ or ▼ button to select "Picture", then press the ENTER button.

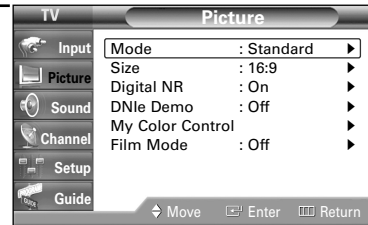

2 Press the ▲ or ▼ button to select "My Color Control", then press the ENTER button.

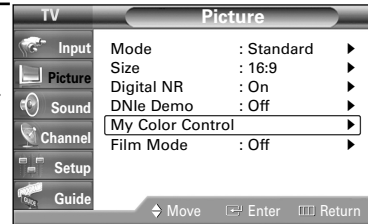

3 Press the ENTER button to select "Easy Control". Press the ◀ or ▶ button to select one of the picture settings you want. The original picture (before adjustment) is shown on the left side, while the selected mode is shown on the right side.



Press the ENTER button to accept the selected mode.

Press the EXIT button to exit.



- "Blue": Emphasizes Clear Blues.
- "Green": Emphasizes Mild Greens.
- "Pink": Emphasizes Warm Skin Colors.
- "Standard": Standard Picture.



## Custom Settings

- 1 Press the MENU button. Press the ▲ or ▼ button to select "Picture", then press the ENTER button. Press the ▲ or ▼ button to select "My Color Control", then press the ENTER button.

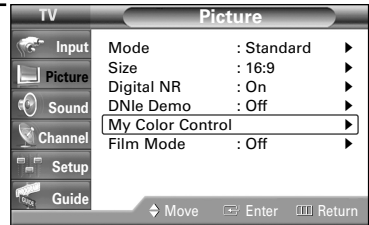

- 2 Press the ▲ or ▼ button to select "Detail Control", then press the ENTER button.

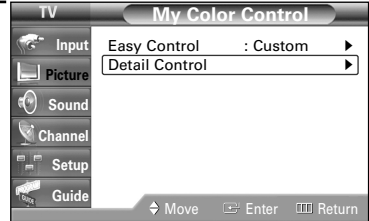

- 3 Press the ▲ or ▼ button to select the desired My Color Control, then press the ENTER button. There are three colors: "Pink", "Green" and "Blue".

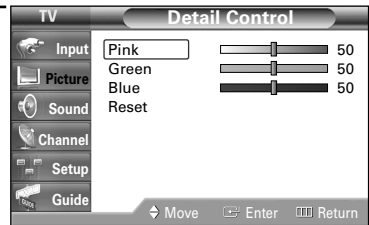

Press the ◀ or ▶ button to adjust the value of a color selected. Changing the adjustment value will refresh the adjusted screen.

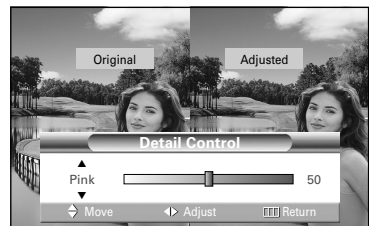

## Resetting the My Color Control Colors to the Factory Defaults

You can return to the factory default settings for My Color Control colors.

- 4 Press the MENU button to display the "Detail Control" menu. Press the ▲ or ▼ button to select "Reset", then press the ENTER button. The previously adjusted My Color Control colors will be reset to the factory defaults.

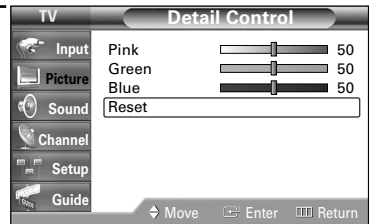

# Picture Control

## Using the Color Weakness Enhancement Feature

This feature adjusts the Red, Green or Blue color to enhance the picture according to the user's particular color weakness.



- 1 Press the MENU button.  
Press the ▲ or ▼ button to select "Setup", then press the ENTER button.

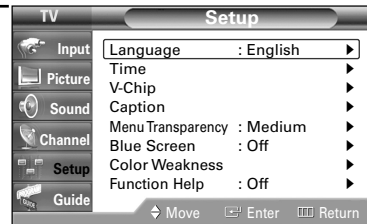

- 2 Press the ▲ or ▼ button to select "Color Weakness", then press the ENTER button.

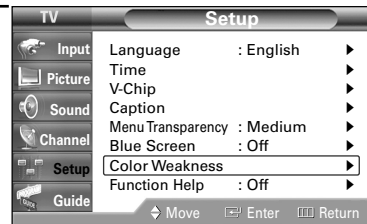

- 3 Press the ENTER button to select "Color Weakness".  
Press the ▲ or ▼ button to select "On", then press the ENTER button.

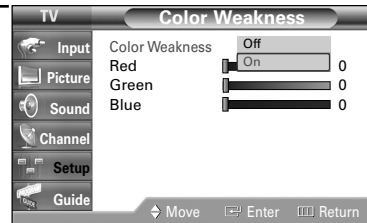

- 4 Press the ▲ or ▼ button to select a color to be adjusted, then press the ENTER button.

Press the ◀ or ▶ button to adjust the value of a color selected.

- You can also select these options (Red, Green or Blue) by pressing the ▲ or ▼ button.

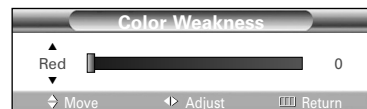
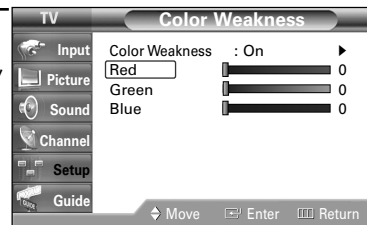

Press the EXIT button to exit.



## Setting the Film Mode

You can automatically sense and process film signals from all sources and adjust the picture for optimum quality.



- 1 Press the MENU button.  
Press the ▲ or ▼ button to select "Picture", then press the ENTER button.

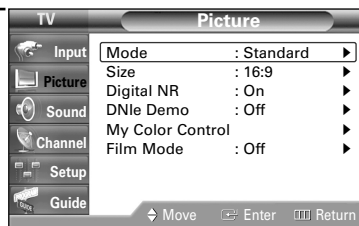

- 2 Press the ▲ or ▼ button to select "Film Mode", then press the ENTER button.

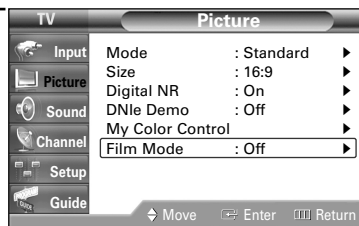

- 3 Press the ▲ or ▼ button to select "Off" or "On", then press the ENTER button.

Press the EXIT button to exit.

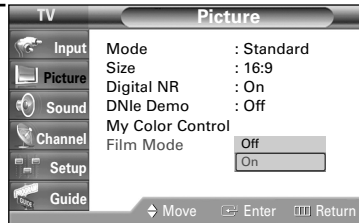

### NOTE

- Film mode is supported in 480i only.

# Picture Control

## Freezing the Picture



Press the STILL button to freeze a moving picture. (Normal sound will still be heard.)

Press again to cancel.

## Setting the Blue Screen Mode

If no signal is being received or the signal is very weak, a blue screen automatically replaces the noisy picture background. If you wish to continue viewing the poor picture, you must set the "Blue Screen" mode to "Off".

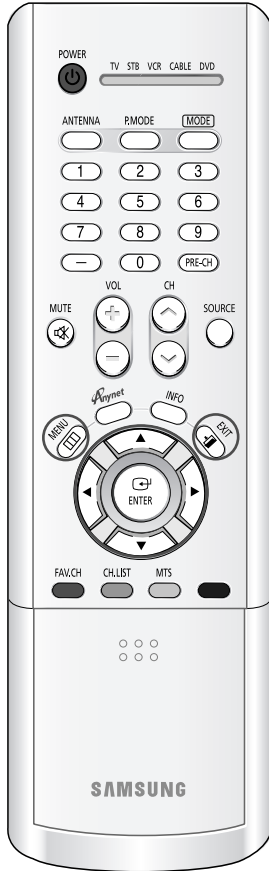

- 1 Press the MENU button.  
Press the ▲ or ▼ button to select "Setup", then press the ENTER button.

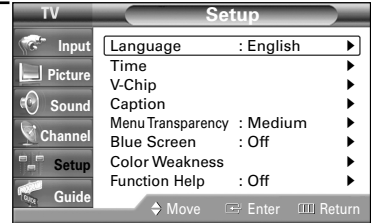

- 2 Press the ▲ or ▼ button to select "Blue Screen", then press the ENTER button.

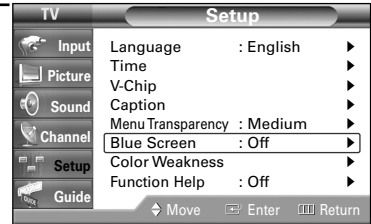

- 3 Press the ▲ or ▼ button to select "On" or "Off", then press the ENTER button.

Press the EXIT button to exit.

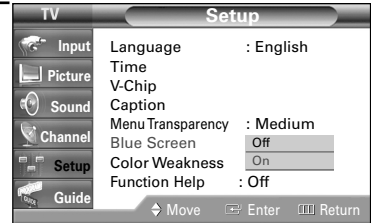

---

SAMSUNG



# **Sound Control**



# Sound Control

## Sound Control

You can control and customize the sound levels and settings of the TV with the remote control.



### Adjusting the Volume

Press the VOL+ or VOL- button to increase or decrease the volume.

### Using the MUTE Button

At any time, you can temporarily cut off the sound.

Press the MUTE button on the remote control.

The message "Mute" is displayed and the sound cuts off.



To turn mute off, press the MUTE button again or press either the VOL+ or VOL- button.

### Customizing the Sound

The sound settings can be adjusted to suit your personal preference. (Alternatively, you can use one of the automatic settings. See next page.)

- 1 Press the MENU button. Press the ▲ or ▼ button to select "Sound", then press the ENTER button.

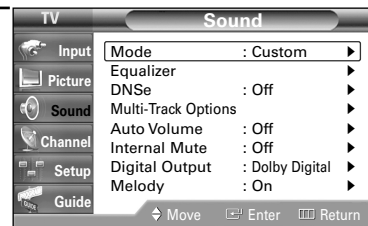

- 2 Press the ▲ or ▼ button to select "Equalizer", then press the ENTER button.

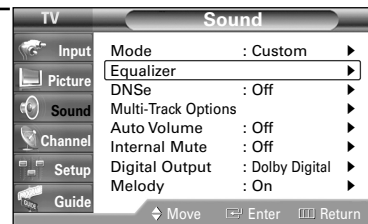

Continued...

- 3 Press the ◀ or ▶ button to select a particular item to be changed. Press the ▲ or ▼ button to increase or decrease the selected frequency.

Press the EXIT button to exit.

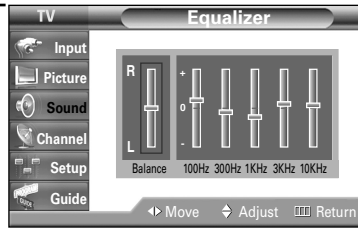

## NOTES

- If you make any changes to the equalizer settings, the sound mode is automatically switched to the custom mode.
- **L/R Sound Balance Adjustment**  
To adjust the sound balance of the L/R speakers.
- **Bandwidth Adjustment (100, 300, 1K, 3K, 10K)**  
To adjust the level of different bandwidth frequencies.

## Using Automatic Sound Settings

Your TV has automatic sound settings (“Standard”, “Music”, “Movie”, and “Speech”) that are preset at the factory. You can select “Custom”, which automatically recalls your personalized sound settings.

- 1 Press the MENU button. Press the ▲ or ▼ button to select “Sound”, then press the ENTER button.

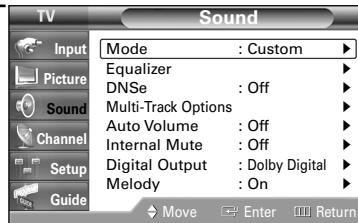

- 2 Press the ENTER button to select “Mode”. Press the ▲ or ▼ button to select a particular item, then press the ENTER button.

Press the EXIT button to exit.

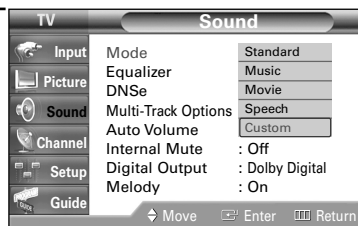

## NOTES

- Choose “Standard” for the standard factory settings.
- Choose “Music” when watching music videos or concerts.
- Choose “Movie” when watching movies.
- Choose “Speech” when watching a show that is mostly dialog (i.e., news).
- Choose “Custom” to recall your personalized settings.

# Sound Control

## Auto Volume

Each broadcasting station has its own signal conditions, and it is inconvenient to adjust the volume every time the channel is changed. "Auto Volume" automatically adjusts the volume of the desired channel by lowering the sound output when the modulation signal is high or by raising the sound output when the modulation signal is low.



- 1 Press the MENU button.  
Press the ▲ or ▼ button to select "Sound", then press the ENTER button.

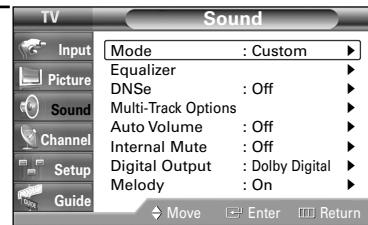

- 2 Press the ▲ or ▼ button to select "Auto Volume", then press the ENTER button.

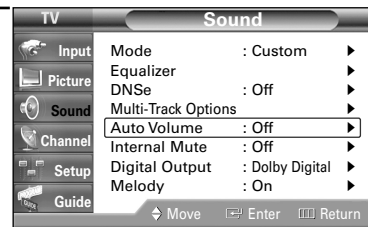

- 3 Press the ▲ or ▼ button to select "Off" or "On", then press the ENTER button.  
  
Press the EXIT button to exit.

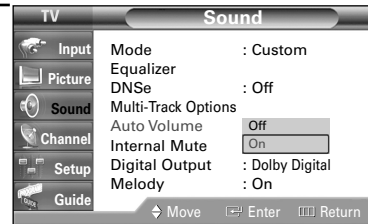



## Choosing a Multi-Channel Sound (MTS) track Digital

The digital-TV transmission system is capable of simultaneous transmission of many audio tracks (for example, simultaneous translations of the program into foreign languages). The availability of these additional "multitracks" depends upon the program.



- 1 Press the MENU button. Press the ▲ or ▼ button to select "Sound", then press the ENTER button.

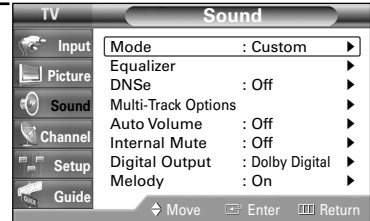

- 2 Press the ▲ or ▼ button to select "Multi-Track Options", then press the ENTER button.

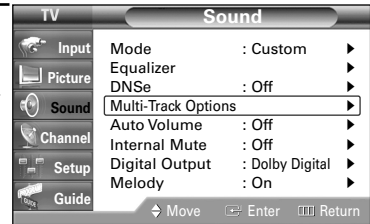

- 3 Press the ENTER button to select "Preferred Language". Press the ▲ or ▼ button to choose the language (English, Spanish or French) you want, then press the ENTER button.

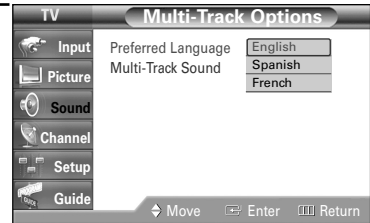

Press the EXIT button to exit.

### Alternate method

Press the MTS button on the remote control. You can listen in a language other than the favorite language by pressing the MTS button.

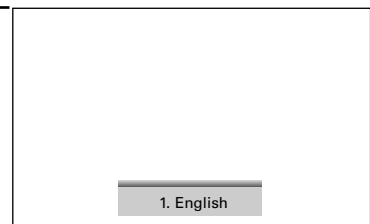

### NOTE

- You can only select the language from among the actual languages broadcast by the broadcasting station. That is, if the current program is broadcast with a configured language (e.g. French), you will listen to the program in the configured Preferred Language. However, if the program is not broadcast with the configured language, you will listen to the program in the default language determined by the broadcasting station (e.g. English).

# Sound Control

## Choosing a Multi-Channel Sound (MTS) track **Analog**

Depending on the particular program being broadcast, you can listen to Mono, Stereo or SAP.



- 1 Press the MENU button.  
Press the ▲ or ▼ button to select "Sound", then press the ENTER button.

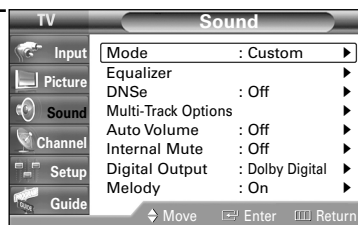

- 2 Press the ▲ or ▼ button to select "Multi-Track Options", then press the ENTER button.

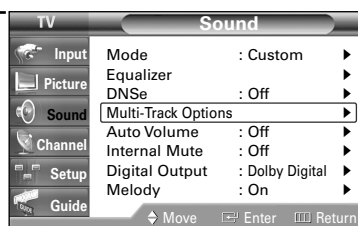

- 3 Press the ▲ or ▼ button to select "Multi-Track Sound", then press the ENTER button. Press the ▲ or ▼ button to select a setting you want, then press the ENTER button.

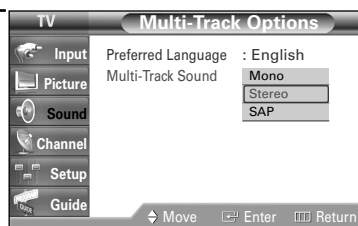

Press the EXIT button to exit.

### Alternate method

Press the MTS button on the remote control repeatedly to select an external signal source.

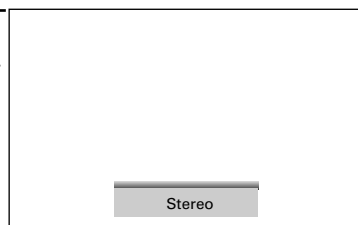

### NOTES

- Choose "Mono" for channels that are broadcasting in mono, or if you are having difficulty receiving a stereo signal.
- Choose "Stereo" for channels that are broadcasting in stereo.
- Choose "SAP" to listen to the Separate Audio Program, which is usually a foreign-language translation.

## Choosing a Digital Sound Format Digital

Digital sound can be output from the rear-panel connector on your TV. The digital sound output is an optical connector labeled "Optical Out". After connecting an optical digital-audio component, you must specify the transmission format (Dolby or PCM, as appropriate to your digital audio component). See the owner's manual of your Digital Audio component for further information.



- 1 Press the MENU button. Press the ▲ or ▼ button to select "Sound", then press the ENTER button.

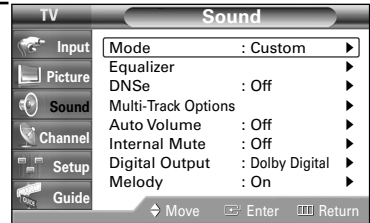

- 2 Press the ▲ or ▼ button to select "Digital Output", then press the ENTER button. Press the ▲ or ▼ button to select "Dolby Digital" or "PCM", then press the ENTER button.

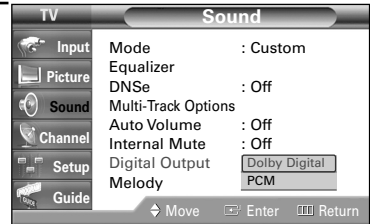

Press the EXIT button to exit.



Manufactured under license from Dolby Laboratories.  
"Dolby" and the double-D symbol are trademarks of Dolby Laboratories.

# Sound Control

## Selecting the Internal Mute

When using a device such as a Home Theater or Amplifier with external speakers, you can set Internal Mute to On to cut off sound from the TV's internal speakers.



- 1 Press the MENU button.  
Press the ▲ or ▼ button to select "Sound", then press the ENTER button.

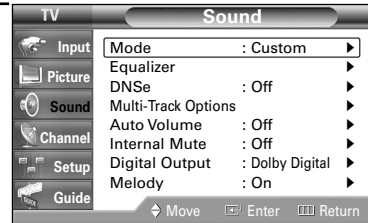

- 2 Press the ▲ or ▼ button to select "Internal Mute", then press the ENTER button.

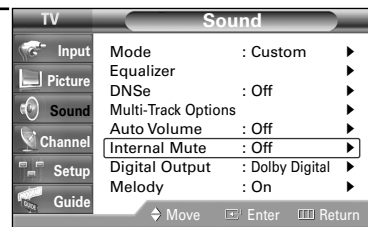

- 3 Press the ▲ or ▼ button to select "On", then press the ENTER button.  
Pressing the ▲ or ▼ button will alternate between "On" and "Off".

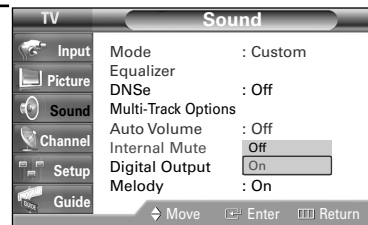

Press the EXIT button to exit.

### NOTES

- The VOL +, VOL - and MUTE buttons do not operate when the Internal Mute is set to On.
- When Internal Mute is set to "On", Sound menus except Multi-Track Options and Digital Output cannot be adjusted.

## Setting the On/Off Melody

A melody sound can be set to come on when the TV is powered On or Off.

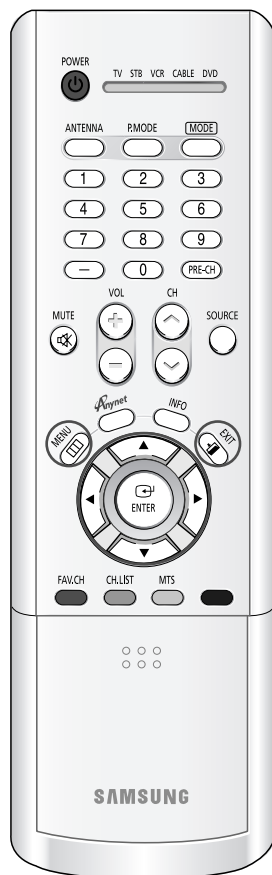

- 1 Press the MENU button.  
Press the ▲ or ▼ button to select "Sound", then press the ENTER button.

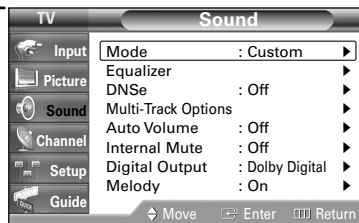

- 2 Press the ▲ or ▼ button to select "Melody", then press the ENTER button.  
Press the ▲ or ▼ button to select "On" or "Off", then press the ENTER button.

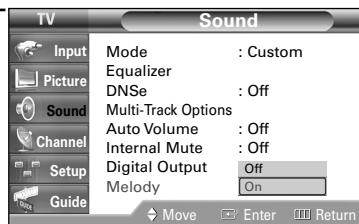

Press the EXIT button to exit.

# Sound Control

## Setting up DNSe (Digital Natural Sound engine)

DNSe enhances the sound quality, automatically controls output, and prevents sound distortion.



- 1 Press the MENU button.  
Press the ▲ or ▼ button to select "Sound", then press the ENTER button.

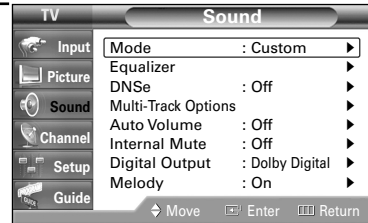

- 2 Press the ▲ or ▼ button to select "DNSe", then press the ENTER button.

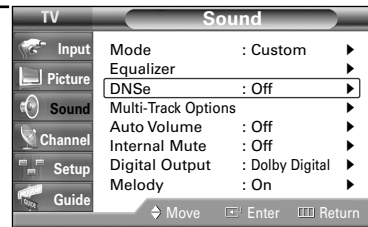

- 3 Press the ▲ or ▼ button to select "On", then press the ENTER button.  
Pressing the ▲ or ▼ button will alternate between "On" and "Off".

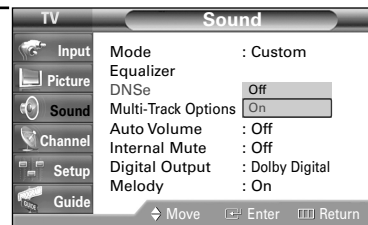

Press the EXIT button to exit.

### Alternate method

Press the DNSe button under the remote's cover repeatedly to select "On" or "Off".

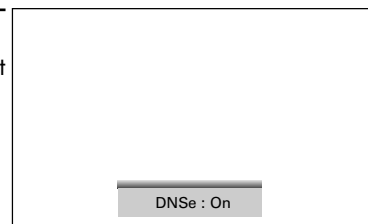



# **Special Features**



# Special Features

## Setting the Function Help

Displays Help on the menu functions.



- 1 Press the MENU button.  
Press the ▲ or ▼ button to select "Setup", then press the ENTER button.

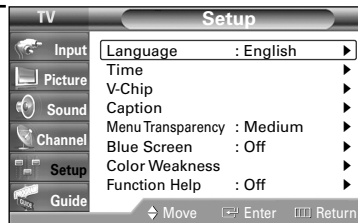

- 2 Press the ▲ or ▼ button to select "Function Help", then press the ENTER button.

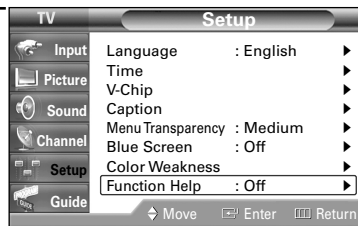

- 3 Press the ▲ or ▼ button to select "On", then press the ENTER button.  
  
Press the EXIT button to exit.

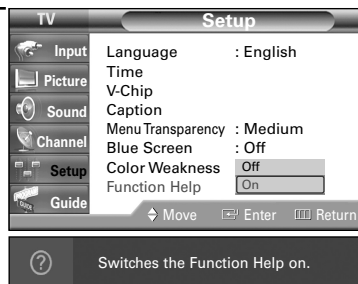



# Menu Transparency Level

Adjusts the transparency of the menu screen.



- 1 Press the MENU button.  
Press the ▲ or ▼ button to select "Setup", then press the ENTER button.

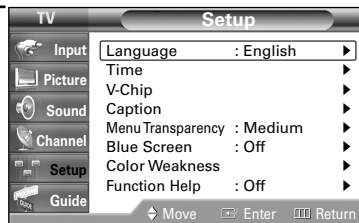

- 2 Press the ▲ or ▼ button to select "Menu Transparency", then press the ENTER button.  
Press the ▲ or ▼ button to select level, then press the ENTER button.

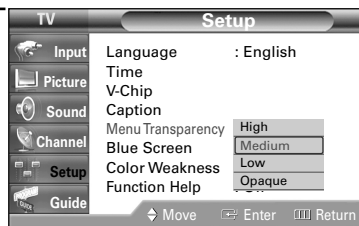

Press the EXIT button to exit.

# Special Features

## Using the V-Chip

Access to channels and programs is controlled by a password (i.e., a 4-digit secret code that is defined by the user). The on-screen menu will instruct you to assign a password (you can change it later, if necessary).



### How to Change Your Password

- 1 Press the MENU button. Press the ▲ or ▼ button to select "Setup", then press the ENTER button. Press the ▲ or ▼ button to select "V-Chip", then press the ENTER button.
- 2 Press the number buttons to enter your current 4-digit pin number. (The default pin number for a new TV set is "0000".) The "V-Chip" menu is displayed.
- 3 Press the ▲ or ▼ button to select "Change PIN", then press the ENTER button.
- 4 Press the number buttons to enter your new 4-digit pin number. Re-enter your new pin number to confirm. Press the EXIT button to exit.

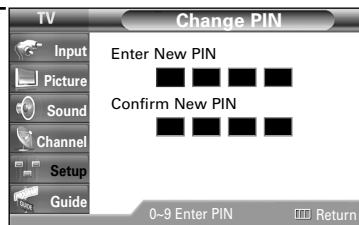
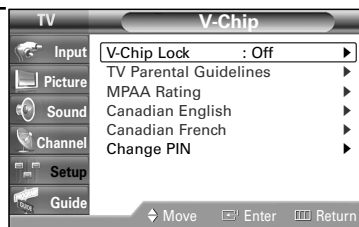
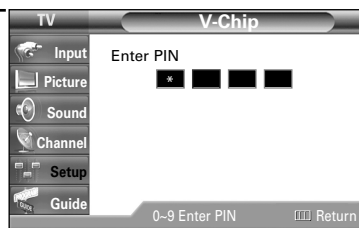
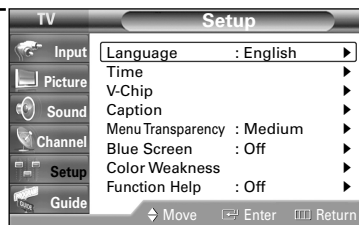

### NOTES

- If you forget the pin number, press the remote control buttons in the following sequence, which resets the pin to 0-0-0-0: POWER (Off), MUTE, 8, 2, 4, POWER (On).
- The V-Chip function only works in RF, AV mode and S-Video mode.

## How to Enable/Disable the Rating Controls



1 Press the MENU button. Press the ▲ or ▼ button to select "Setup", then press the ENTER button. Press the ▲ or ▼ button to select "V-Chip", then press the ENTER button.

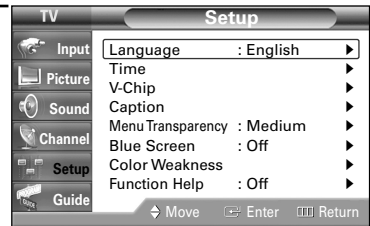

2 Press the number buttons to enter your current 4-digit pin number. (The default pin number for a new TV set is "0000".) The "V-Chip" menu is displayed.

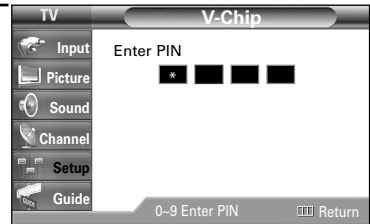

3 The "V-Chip" screen will appear. To enable the V-Chip feature, press the ENTER button so that the "V-Chip Lock" field is "On". (Pressing the ▲ or ▼ button will alternate between "On" and "Off".) Press the ENTER button.

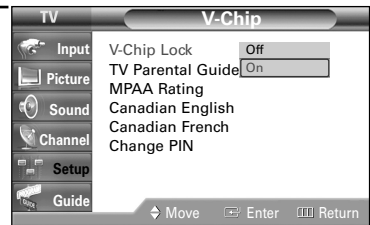

Press the EXIT button to exit.

# Special Features

## How to Set up Restrictions Using the “TV Parental Guidelines”

The parental restrictions can be set up using either of two methods: The “TV Parental Guidelines” or “MPAA Rating”.

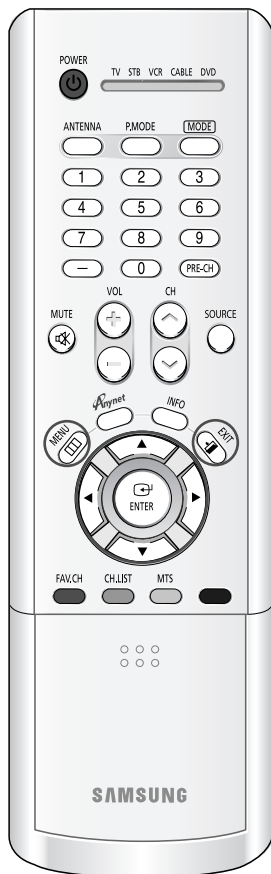

- 1 Press the MENU button.  
Press the ▲ or ▼ button to select “Setup”, then press the ENTER button.  
Press the ▲ or ▼ button to select “V-Chip”, then press the ENTER button.

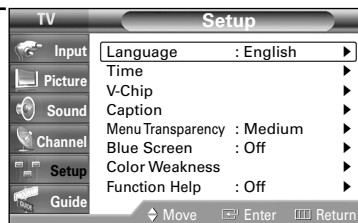



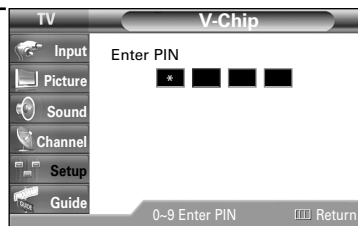

- 2 Press the number buttons to enter your current 4-digit pin number.  
(The default pin number for a new TV set is “0000”.)  
The “V-Chip” menu is displayed.



- 3 Press the ▲ or ▼ button to select “TV Parental Guidelines”, then press the ENTER button.



- 4 You can independently lock the TV ratings. The locked TV (FCC) ratings are indicated by the symbol “”. To unlock a locked channel, press the ENTER button again.

Press the /// buttons and the ENTER button to activate the appropriate restrictions for TV (FCC) rating system.

TV-Y : Young children  
TV-Y7 : Children 7 and over  
TV-G : General audience  
TV-PG : Parent Guidance  
TV-14 : Viewers 14 and over  
TV-MA : Mature Audience

Press the EXIT button to exit.

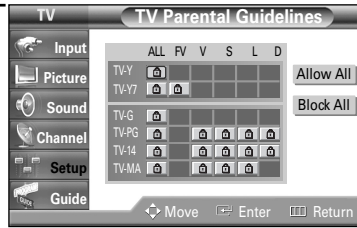

#### NOTE

- *Allow All* : Press to unlock all TV ratings.
- *Block All* : Press to lock all TV ratings.

#### NOTES

- These categories consist of two separate groups: “TV-Y” and “TV-Y7” (young children through age 7), and “TV-G” through “TV-MA” (everybody else).
- The restrictions for these two groups work independently: If a household includes very young children as well as young adults, the TV parental guidelines must be set up separately for each age group. (See page 79.)

# Special Features

## How to Set up Restrictions Using the “MPAA Rating”

The Movie rating system uses the “MPAA” (Motion Picture Association of America) system, and its main application is for movies.

When the rating control is on, the TV will automatically block any programs that are coded with objectionable ratings (either “MPAA Rating” or “TV Parental Guidelines”).



- 1 Press the MENU button.  
Press the ▲ or ▼ button to select “Setup”, then press the ENTER button.  
Press the ▲ or ▼ button to select “V-Chip”, then press the ENTER button.

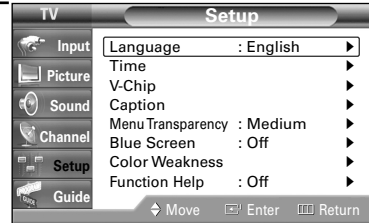

- 2 Press the number buttons to enter your current 4-digit pin number.  
(The default pin number for a new TV set is “0000”.)  
The “V-Chip” menu is displayed.

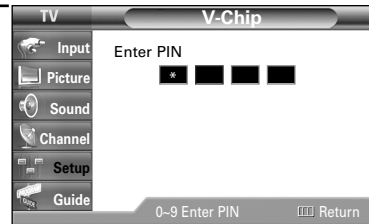

- 3 Press the ▲ or ▼ button to select “MPAA Rating”, then press the ENTER button.

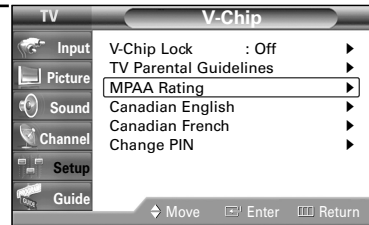

- 4 You can independently lock the movie ratings. The locked movie ratings are indicated by the symbol “🔒”.  
To unlock a locked channel, press the ENTER button again.

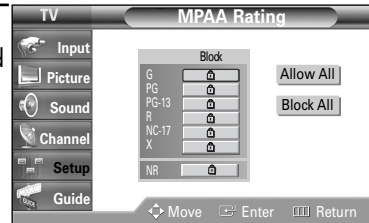

Press the ▲/▼/ENTER buttons to activate the appropriate restrictions for movie rating system.

Press the EXIT button.

### NOTE

- Allow All : Press to unlock all movie ratings.  
Block All : Press to lock all movie ratings.

## Important Notes About Parental Locks

Explanation of the MPAA and TV (FCC) Rating Systems:

### TV (FCC) Age-Based Ratings

#### TV-MA

Mature audiences only. This program may contain mature themes, profane language, graphic violence and explicit sexual content.

#### TV-14

Parents strongly cautioned. This program may contain sophisticated themes, sexual content, strong language and more intense violence.

#### TV-PG

Parental guidance suggested. The program may contain infrequent coarse language, limited violence, some suggestive sexual dialog and situations.

#### TV-G

General audience. It contains little or no violence, no strong language, and little or no sexual dialog or situations.

#### TV-Y7

Directed to older children. Themes and elements in this program may include mild physical or comedic violence, or may frighten children under the age of seven.

#### TV-Y

All children. The themes and elements in this program are specifically designed for a very young audience, including children from ages two – six.

### TV (FCC) Content Category

<b>V</b>	Violence.
<b>S</b>	Sexual content.
<b>L</b>	Offensive language.
<b>D</b>	Dialog sexual innuendo.
<b>FV</b>	Fantasy or cartoon violence.

### MPAA Rating System (Movies)

<b>G</b>	General audience. No restriction.
<b>PG</b>	Children under 13 should be accompanied by an adult.
<b>PG-13</b>	Parental guidance suggested. Children under 13 should be accompanied by an adult.
<b>R</b>	Restricted. Viewers should be 17 or older.
<b>NC-17</b>	Not classified. Viewers should be 17 or older.
<b>X</b>	Adults only.
<b>NR</b>	Not rated.

- TV (FCC) ratings : The particular rating that you have selected will be locked (and indicated as a red "L" on a blue background). Also, all of the age-based ratings will be locked within the particular group (i.e., "group 1" or "group 2"). Suppose that the TV-G rating and all of its contents (V, S, L, and D) are locked. In that case, more restrictive ratings (TV-PG, TV-14, and TV-MA) and all of their contents (V, S, L, and D) are automatically locked as well.
- MPAA ratings : The particular rating that you have selected will be locked. In addition, more restrictive ratings will be locked as well.
- Neither TV (FCC) ratings nor MPAA ratings apply to news programs.

# Special Features

## How to Set up Restrictions Using Canadian English



1 Press the MENU button. Press the ▲ or ▼ button to select "Setup", then press the ENTER button.

Press the ▲ or ▼ button to select "V-Chip", then press the ENTER button.

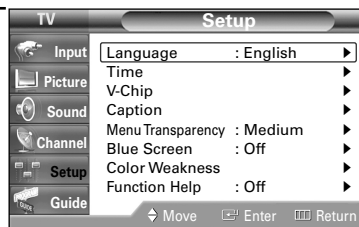

2 Press the number buttons to enter your current 4-digit pin number. (The default pin number for a new TV set is "0000".) The "V-Chip" menu is displayed.

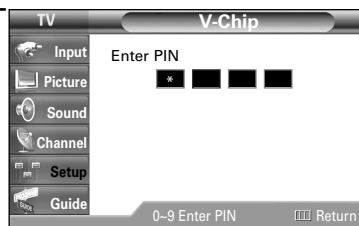

3 Press the ▲ or ▼ button to select "Canadian English", then press the ENTER button.

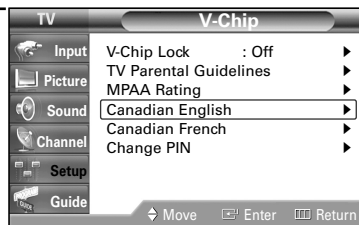



4 Press the ▲ or ▼ button to select a appropriate restriction.

Press the ENTER button to activate the restriction selected.  
The "🔒" symbol is indicated.  
To unlock a locked channel, press the ENTER button again.

Press the EXIT button.

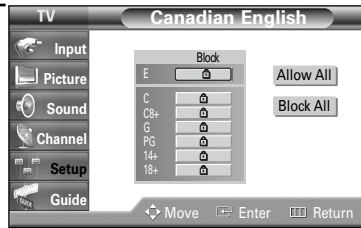

**NOTE**

- *Allow All* : Press to unlock all TV ratings.
- *Block All* : Press to lock all TV ratings.

- |            |   |
|------------|---|
| <b>E</b>   | Exempt programming includes...news, sports, documentaries and other information programming, talk shows, music videos, and variety programming. |
| <b>C</b>   | Programming intended for children under age 8.  |
| <b>C8+</b> | Programming generally considered acceptable for children 8 years and over to watch on their own.  |
| <b>G</b>   | General programming, suitable for all audiences.  |
| <b>PG</b>  | Parental Guidance.  |
| <b>14+</b> | Programming contains themes or content which may not be suitable for viewers under the age of 14.   |
| <b>18+</b> | Adult programming.  |

# Special Features

## How to Set up Restrictions Using Canadian French



- 1 Press the MENU button.  
Press the ▲ or ▼ button to select "Setup", then press the ENTER button.

Press the ▲ or ▼ button to select "V-Chip", then press the ENTER button.

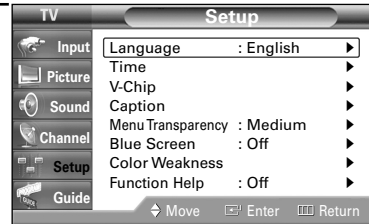

- 2 Press the number buttons to enter your current 4-digit pin number.  
(The default pin number for a new TV set is "0000".)  
The "V-Chip" menu is displayed.

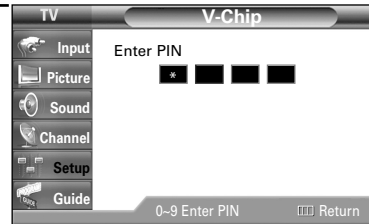

- 3 Press the ▲ or ▼ button to select "Canadian French", then press the ENTER button.

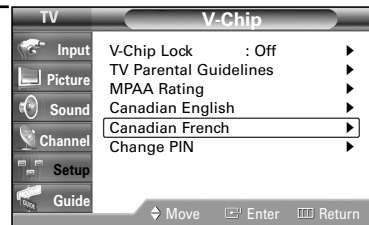

4 Press the ▲ or ▼ button to select a appropriate restriction.

Press the ENTER button to activate the restriction selected.

The "🔒" symbol is indicated.

To unlock a locked channel, press the ENTER button again.

Press the EXIT button.

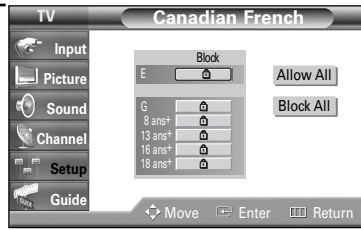

#### **NOTE**

- *Allow All* : Press to unlock all TV ratings.
- *Block All* : Press to lock all TV ratings.

- E** Exempt programming includes...news, sports, documentaries and other information programming, talk shows, music videos, and variety programming.
- G** General.
- 8 ans+** 8+ General-Not recommended for young children.
- 13 ans+** Programming may not be suitable for children under the age of 13.
- 16 ans+** Programming is not suitable for children under the age of 16.
- 18 ans+** Programming restricted to adults.

# Special Features

## Viewing Closed Captions (On-Screen Text Messages) **Analog**

The Analog Caption function operates in either analog RF channel mode or external signal mode. (Depending on the broadcasting signal, the Analog Caption function may operate on digital channels.)



- 1 Press the MENU button.  
Press the ▲ or ▼ button to select "Setup", then press the ENTER button.

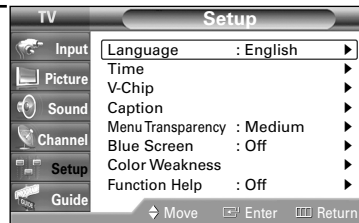

- 2 Press the ▲ or ▼ button to select "Caption", then press the ENTER button.

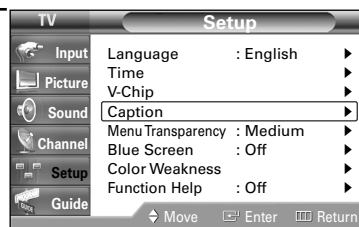

- 3 Press the ENTER button to select "Caption".

Press the ▲ or ▼ button to select "On", then press the ENTER button.

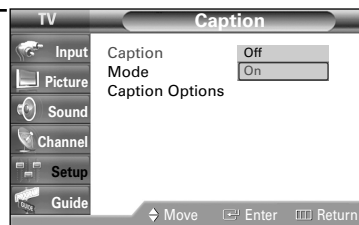

- 4 Press the ▲ or ▼ button to select “Mode”, then press the ENTER button.  
Press the ▲ or ▼ button to select submenu (CC1~CC4 or Text1~Text4) you want, then press the ENTER button.

Press the EXIT button to exit.

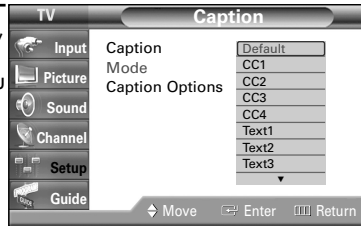

## NOTES

- The default is “CC1”.
  - CC1 : The Primary Synchronous Caption Service. These are captions in the primary language that must be in sync with the sound, preferably matched to a specific frame.
  - CC2 : The Special NonSynchronous Use Captions. This channel carries data that is intended to augment information carried in the program.
  - CC3 : Secondary Synchronous Caption Service. Alternate program-related caption data, typically second language captions.
  - CC4 : Special Non-Synchronous Use Captions. Similar to CC2.
  - Text1 : First Text Service. This may be various non-program related data.
  - Text2 : Second Text Service. Additional data, usually not program related.
  - Text3/Text4 : Third and Fourth Text Services. These data channels should be used only if Text1 and Text2 are not sufficient.
- The Caption feature only works in RF, AV and S-Video mode.
- The availability of captions depends on the program being broadcast.

# Special Features

## Viewing Closed Captions (On-Screen Text Messages) **Digital**

The Digital Captions function operates on digital channels.

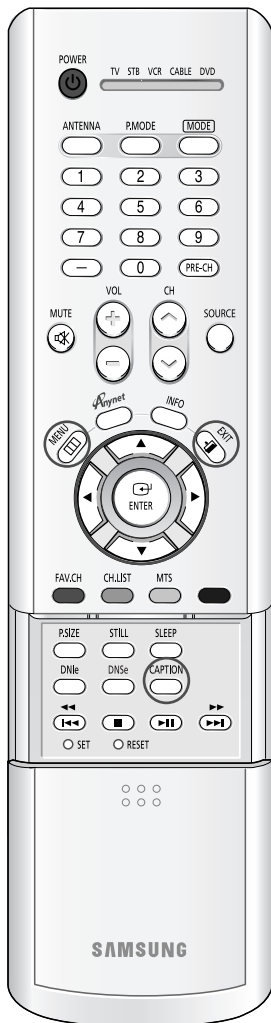

### NOTE

- "Caption Options" are available only when "Service1~Service6" can be selected in "Mode".

- 1 Press the MENU button.  
Press the ▲ or ▼ button to select "Setup", then press the ENTER button.

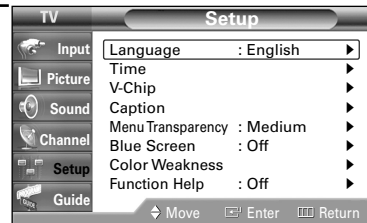

- 2 Press the ▲ or ▼ button to select "Caption", then press the ENTER button.

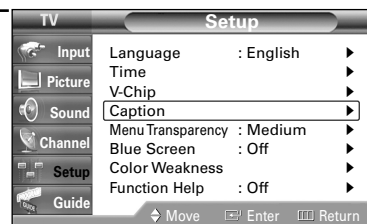

- 3 Press the ENTER button to select "Caption".

Press the ▲ or ▼ button to select "On", then press the ENTER button.

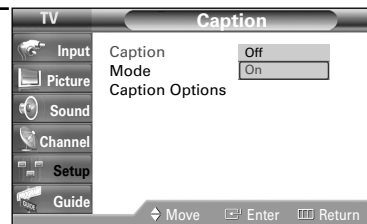

- 4 Press the ▲ or ▼ button to select "Mode", then press the ENTER button.  
Press the ▲ or ▼ button to select submenu (Service 1~Service 6, CC1~CC4 or Text1~Text4) you want, then press the ENTER button.

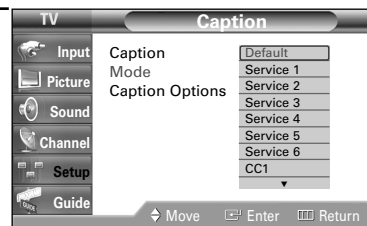

- 5 Press the ▲ or ▼ button to select "Caption Options", then press the ENTER button.

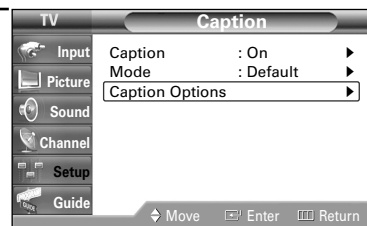

- 6 Press the ▲ or ▼ button to select “Size”, then press the ENTER button.  
 Press the ▲ or ▼ button to select one you want, then press the ENTER button.  
 Set other listed options below using the same method as above.  
 Press the EXIT button to exit.

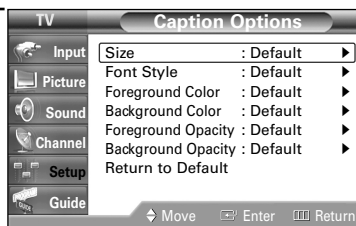

## NOTE

- The availability of captions depends on the program being broadcast.

### Size

This option consists of “Default”, “Small”, “Standard”, and “Large”. The default is “Standard”.

### Font Style

This option consists of “Default”, “Style0 ~ Style 7”. You can change the font you want. The default is “Style 0”.

### Foreground Color

This option consists of “Default”, “White”, “Black”, “Red”, “Green”, “Blue”, “Yellow”, “Magenta”, and “Cyan”. You can change the color of the letter. The default is “White”.

### Background Color

This option consists of “Default”, “White”, “Black”, “Red”, “Green”, “Blue”, “Yellow”, “Magenta”, and “Cyan”. You can change the background color of the caption. The default is “Black”.

### Foreground Opacity

This option consists of “Default”, “Transparent”, “Translucent”, “Solid”, and “Flashing”. You can change the opacity of the letter.

### Background Opacity

This option consists of “Default”, “Transparent”, “Translucent”, “Solid”, and “Flashing”. You can change the background opacity of the caption.

### Return to Default

This option sets each of “Size”, “Font Style”, “Foreground Color”, “Background Color”, “Foreground Opacity”, and “Background Opacity” Color to its default.

## Alternate method

Press the CAPTION button under the remote’s cover repeatedly to select “On” or “Off”.

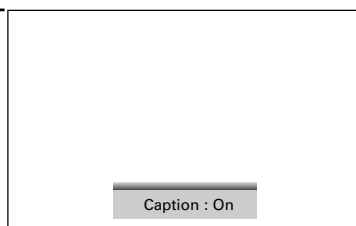

# Special Features

## Using the Guide

You can display a list of all channels or your favorite channels.



- 1 Press the MENU button.  
Press the ▲ or ▼ button to select "Guide", then press the ENTER button.



- 2 Press the ▲ or ▼ button to select "Channel List" or "Favorite Channel List", then press the ENTER button.

Press the CH ▲ or CH ▼ button to display the previous or next channel list page.

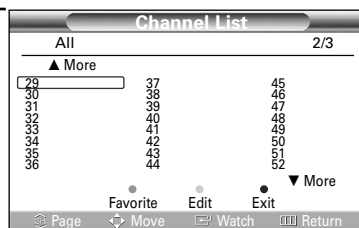

- Yellow button : Press to edit channels.  
The edit channel menu is displayed.  
(See next page for details.)
- Green button : Press to toggle between your all or favorite channels.
- Blue or EXIT button : Press to exit.

### Alternate method

Press the CH.LIST button on the remote control to display a list of channels.

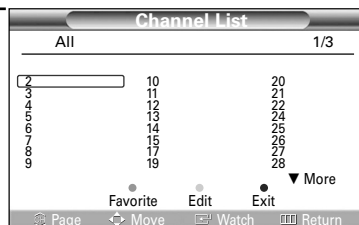



## Adding and Erasing Channels

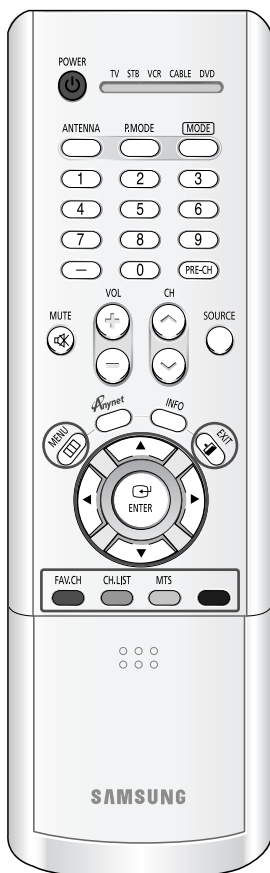

- 1 Press the MENU button.  
Press the ▲ or ▼ button to select "Guide", then press the ENTER button.



- 2 Press the ▲ or ▼ button to select "Edit Channel List", then press the ENTER button.



- 3 Press the ▲ or ▼ button to change channels you want to add or delete.  
Repeatedly pressing ENTER button will alternate between "Add" and "Delete".

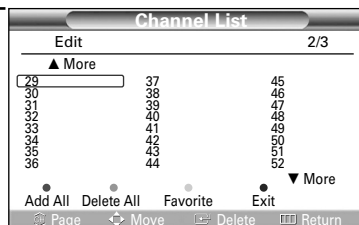

Press the ▲ or ▼ button to select favorite channel you want to add, then press the yellow button.

The check (✓) mark will appear.

Press the yellow button again to deselect the selected channel and the check (✓) mark will disappear.

Press the CH ▲ or CH ▼ button to display the previous or next channel list page.

- Red button : Press to add all channels of the channel list.
- Green button : Press to delete all channels of the channel list.
- Yellow button : Press to add favorite channels.
- Blue or EXIT button : Press to exit.

### NOTE

- To use Favorite Channels, first add channels.

# Special Features

## Using Game Mode

When playing a game by connecting to a game console such as PlayStation or Xbox, you can enjoy a more realistic gaming experience by selecting Game mode.



1 Press the MENU button. Press the ENTER button to select "Input".

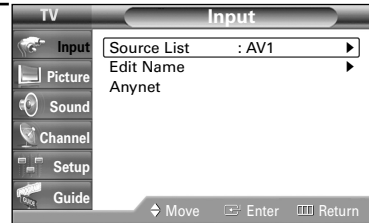

2 Press the ▲ or ▼ button to select "Edit Name", then press the ENTER button.

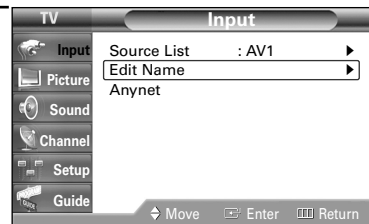

3 Press the ▲ or ▼ button to select a signal source to edit, then press the ENTER button.

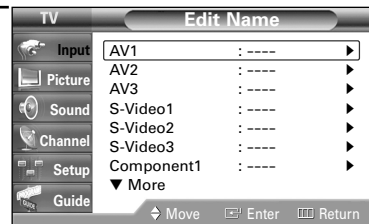

4 Press the ▲ or ▼ button to select "GAME", then press the ENTER button.  
Press the EXIT button to exit.

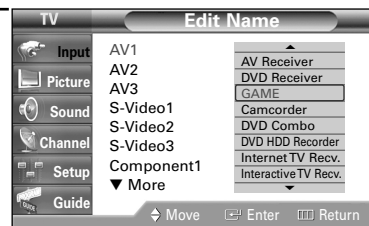

### NOTES

- Game mode is only available for AV1, AV2, AV3, S-Video1, S-Video2, S-Video3, Component1 and Component2.
- For Component input, Game mode only supports a resolution of 480i.

### Restrictions on Game Mode (Caution)

- To Disconnect the game console and connect another external device, cancel Game mode in the Edit name.
- If you display an OSD in Game mode, the screen shakes slightly.



# Appendix



## Replacing the Lamp

- **Why do I need to replace the lamp?**

The lamp used in a DLP TV has a limited lifespan. For the best screen quality it needs to be replaced periodically. After replacing the lamp, the screen quality will be bright and clear as new.

- **When do I need to replace it?**

It should be replaced when the screen becomes darker, less clear or when all three LEDs on the front (TIMER, LAMP, & STAND BY/TEMP) are flashing.

- **Check before lamp replacement**

1. The lamp must be the same code number and type.
2. The lamp type is indicated on the right side of the TV. It is also indicated on the lamp case.
3. After checking the code number for the lamp, give the code number to the store where you purchased the TV or to a Samsung Service center.

- **Caution**

1. Replace with the correct code numbered lamp to avoid damage to the TV.
2. Turn the power off and wait for 30 minutes before replacing the lamp as it will be hot.
3. Do not touch the glass part of the lamp with your bare hands nor insert any foreign object inside the cover as it may cause poor screen quality, electric shock or fire.
4. Do not place the old lamp near flammable objects or within the reach of children.
5. Be sure to connect this TV directly to an AC wall outlet. If the TV's AC plug is connected to a cable box or other source, it will not allow for proper cool down time.

- For replacement, you will need a 5.91-Inch screwdriver and a pair of gloves.

1 Unplug TV, then use a screwdriver to remove the screws.



2 Remove the Lamp cover.



3 Remove the screw securing the Lamp by using a screwdriver.

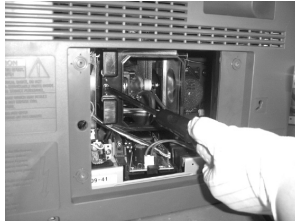

4 Separate the Lamp from the engine by holding the handle and pulling it out.



5 To reinstall the Lamp, follow these steps in reverse order.

## NOTES

- Be sure the replacement Lamp is the same type.
- After replacing the lamp, align the lamp cover with the groove and secure the screws.
- The TV will not turn on if the lamp cover is not correctly closed (as this will activate the protective circuit).

# Appendix

## Troubleshooting

If the TV seems to have a problem, first try this list of possible problems and solutions. If none of these troubleshooting tips apply, then call your nearest Samsung authorized service center.

Problem	Possible Solution
Poor picture quality.	Try another channel. Adjust the antenna. Check all wire connections.
Poor sound quality.	Try another channel. Adjust the antenna. Make sure the MUTE button is off.
No picture or sound.	Try another channel. Press the SOURCE button. Make sure the TV is plugged in. Check the antenna connections. Check that the Mute feature is off.
No color, wrong colors or tints.	Make sure the program is broadcasted in color. Adjust the picture settings.
Picture rolls vertically.	Adjust the antenna. Check all wire connections. If you are using a VCR, check the tracking.
The TV operates erratically.	Unplug the TV for 30 seconds, then try operating it again.
Your remote control does not operate your TV.	Press the MODE button to put your remote control into TV mode. Make sure the remote has batteries.
The TV won't switch on.	Make sure the wall outlet is working. Make sure the TV is plugged in. Make sure the remote has batteries.
Digital broadcasting screen problem.	Please check the digital signal strength and input antenna.
The visual qualities of digital channels vary.	The visual qualities of digital channels may vary depending on the original production method (analog or digital). → Classification by the information displayed when switching channels. → If the original production method is digital: High visual quality program. → If the original production method is analog: The digital program displayed on the screen is originally an analog program which has been converted. The visual quality is of an SD grade.
Although the TV caption shows HD, the visual quality is not satisfactory.	The HD caption that appears when switching channels or when pressing the Information button on the remote control means the selected channel is simply a digital channel. If the broadcasting station converts an analog signal into digital and transmits the signal, the visual quality may not be perfect. (Applied to Set Top Box built-in model only.)

- The display panel used for the DLP TV is composed of many tiny pixels. These pixels may occasionally appear on the screen.

## Cleaning and Maintaining Your TV

With proper care, your TV will give you many years of service. Please follow these guidelines to get the maximum performance from your TV.

### Placement

- Do not put the TV near extremely hot, cold, humid or dusty places.
- Do not place the TV near appliances with electric motors that create magnetic fields, such as vacuum cleaners.
- Keep the ventilation openings clear; do not place the TV on a soft surface, such as cloth or paper.
- Place the TV in a vertical position only.

### Liquids

- Do not handle liquids near or on the TV. Liquids that spill into it can cause serious damage.

### Cabinet

- Never open the cabinet or touch the parts inside.
- Wipe your TV with a clean, dry cloth. Never use water, cleaning fluids, wax, or chemicals.
- Do not put heavy objects on top of the cabinet.
- This DLP TV projects the image onto a large screen by applying an optical system. If you place the TV set face down, it might cause a problem because dirt, or some other contaminant may become attached to the inside of the TV set.

### Temperature

- If your TV is suddenly moved from a cold to a warm place, unplug the power cord, and allow at least two hours for moisture that may have formed inside the unit to dry completely.

## Using Your TV in Another Country

If you plan to take your TV with you to a foreign country, please be aware of the different television systems that are in use around the world. A TV designed for one system may not work properly with another system due to differences in the TV channel frequencies.

## Specifications

Model	HLR4656W	HLR5056W	HLR5656W	HLR6156W
Voltage	AC110-120V~	AC110-120V~	AC110-120V~	AC110-120V~
Frequency of Operation	60Hz	60Hz	60Hz	60Hz
Power Consumption	230 watts	230 watts	230 watts	230 watts
Dimensions (W x D x H)	43.07 x 13.35 x 32.05 inches 1094 x 339 x 814 mm	46.54 x 14.13 x 34.25 inches 1182 x 359 x 870 mm	52.36 x 15.59 x 37.89 inches 1330 x 396 x 962.5 mm	56.93 x 18.27 x 41.65 inches 1446 x 464 x 1058 mm
Weight	32.5 Kg / 71.65 lbs	36 Kg / 79.37 lbs	42.5 Kg / 93.70 lbs	49 Kg / 108.02 lbs



**ELECTRONICS**

**1-800-SAMSUNG (1-800-726-7864)**

**Samsung Electronics America  
Service Division**

400 Valley Road, Suite 201  
Mount Arlington, NJ 07856  
[www.samsung.com](http://www.samsung.com)

**Samsung Electronics Canada Inc.  
Samsung Customer Care**

55 Standish Court  
Mississauga, Ontario  
L5R 4B2  
[www.samsung.ca](http://www.samsung.ca)